

USER MANUAL

NANLUX

INNOVATE · ILLUMINATE

TK-200/TK-450

LED DAYLIGHT SOFT PANEL LIGHT

WWW.NANLUX.COM

Contents

Product Diagram	01		
Technical Data	01		
Product Details	02		
Detailed Description	03		
Power Connection	04		
Remote Control			
1. ADDRESS/DMX	05		
2. DMX Remote Control	08		
3. 2.4G Remote Control	10		
4. RDM Remote Control	11		
5. LUMENRADIO Remote Control	12		
Operating Instructions			
1. Screen Interface Display Instructions	14		
2. DAYLIGHT Key	14		
3. EFFECT Key	15		
		4. MENU Key	29
		①ADDRESS/DMX	29
		②WIRELESS PROTOCOL	29
		③LUMENRADIO SETTINGS	29
		④ROTATE SCREEN	30
		⑤SCREEN BRIGHTNESS	31
		⑥BUTTON BACKLIGHT	32
		⑦LANGUAGE	33
		⑧VERSION	34
		5. LOCK Key	34
		Safety Precautions	35
		Notice	35
		General Fault Detection and Diagnosis	35
		Product Includes	36

TK-200/TK-450 LED Daylight Soft Panel Light

Product Diagram

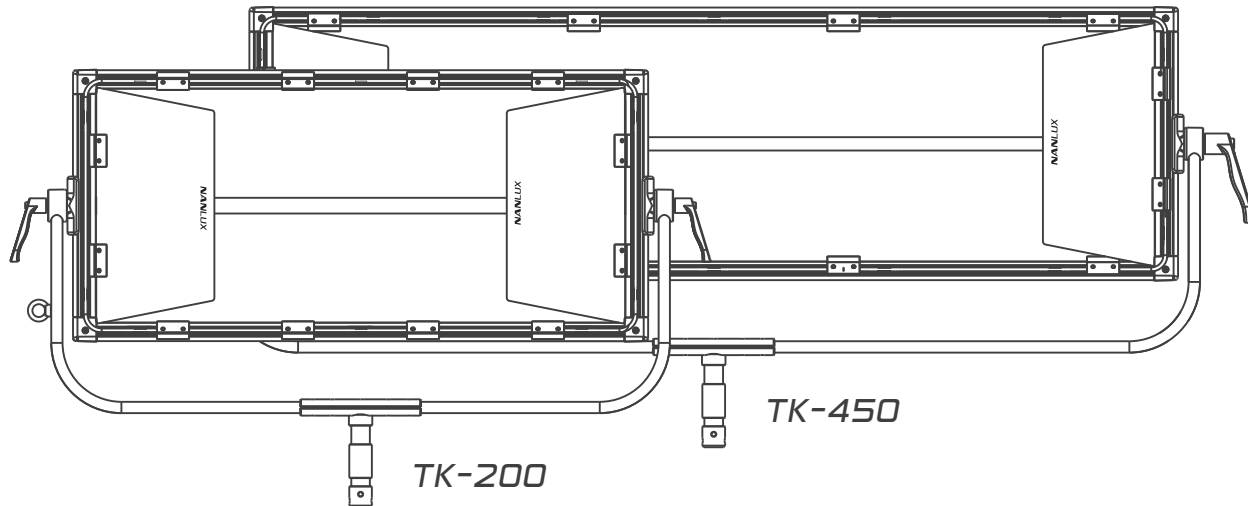

Technical Data

Model No.: TK-200

Rated power: 240W

Input voltage/current: DC24V/10.4A Max

AC100-240V 50/60HZ

CCT: 5600K

CRI: 96

TLCI: 98

Model No.: TK-450

Rated power: 455W

Input voltage/current: DC48V/10A Max

AC100-240V 50/60HZ

CCT: 5600K

CRI: 96

TLCI: 98

Product Details

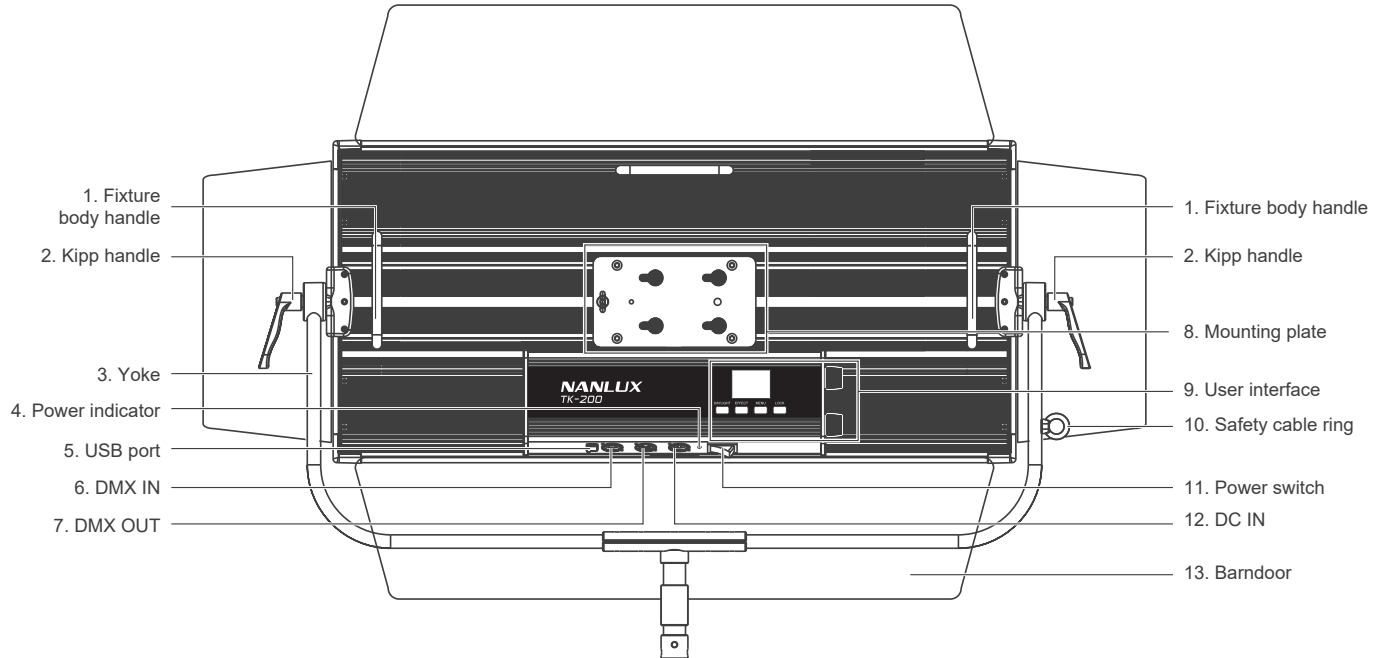

Detailed Description

1. Fixture body handle: For lift the fixture and adjust the direction of the fixture.
2. Kipp handle: Tighten or release the tilt movement of the fixture on the yoke.
3. Yoke: Mount the fixture on a stand; pan and tilt.
4. Power indicator: Check the status of the power input. Indicator always on: normal power supply; Indicator flashing or off: abnormal power supply or no power input.
5. USB port: Install firmware updates.
6. DMX IN: DMX signal input interface.
7. DMX OUT: DMX signal output interface.
8. Mounting plate: For installing gooseneck base or 5/8 pin base.
9. User interface: Display and control functions, operations and data.
10. Safety cable ring: Attach safety rope to secure the diffuser.
11. Power switch: Turn on/off the fixture.
12. DC IN: DC power Input interface.
13. Barndoor: For controlling the spill of light.

Power Connection

1. When connecting the power supply, please make sure the power, voltage and frequency is consistent with the provided power supply.

▲Note: ① Make sure to use the provided power supply and power cable.

② The connection between plug on power supply and the power cable on the fixture should be connected as following.

· TK-200



DC IN

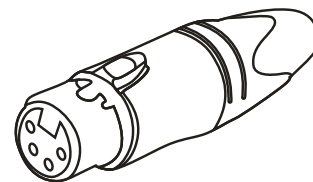
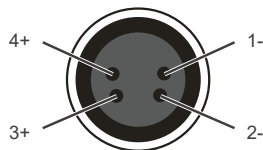

· TK-450

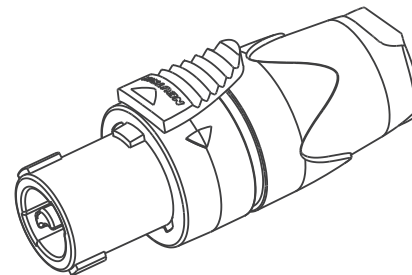
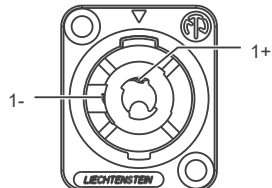
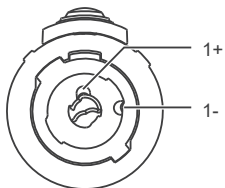

Remote Control

- TK-200/TK-450 supports remote control via DMX, 2.4G, RDM, LUMENRADIO, and has built-in bluetooth.
- ▲ The ADDRESS needs to be set before operating the remote control via DMX, 2.4G, RDM and LUMENRADIO.

1. ADDRESS/DMX, including ADDRESS, DMX MODE and DMX DIMMING CURVE setting.

① ADDRESS

Press MENU key to access options.

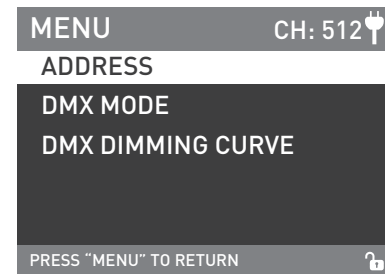
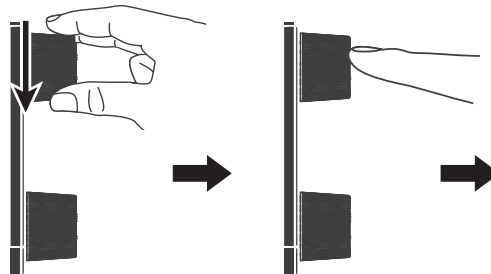
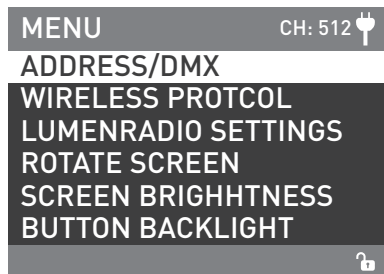
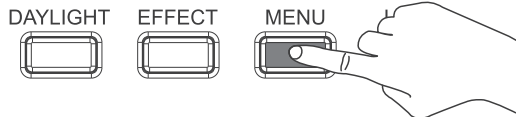
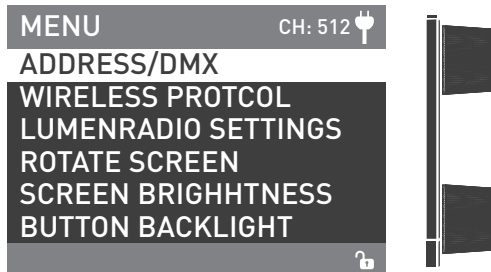

Rotate "Upper knob" to ADDRESS/DMX, press "Upper knob" to enter the corresponding secondary menu.

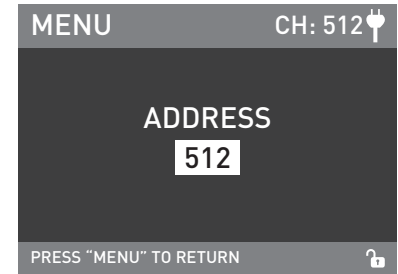
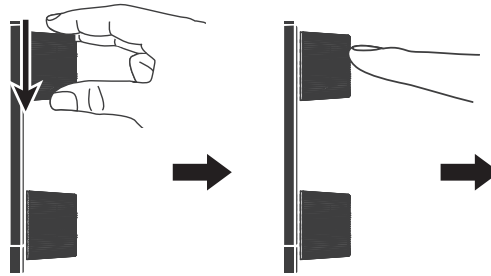
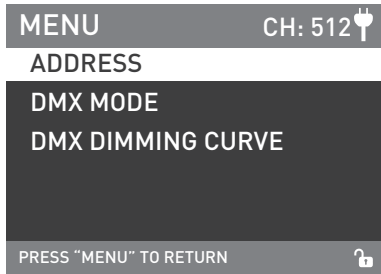

Rotate "Upper knob" to ADDRESS and press "Upper knob" to enter corresponding third menu.

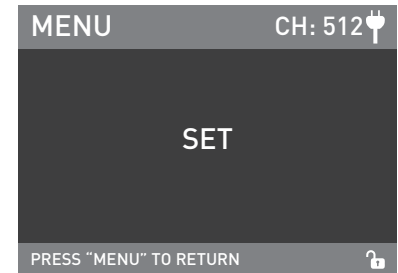
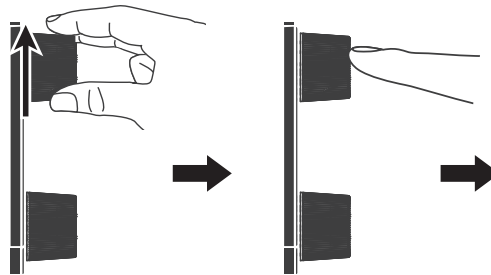
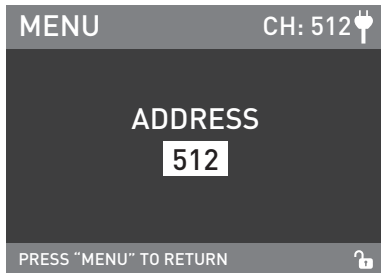

Rotate "Upper knob" to select the desired ADDRESS number and press "Upper knob" to set.

Note: TK-200/TK-450 has 9 channels, for multiple lights remote control via DMX, 2.4G, RDM, LUMENRADIO, the address of the first light is set to 001, the second one is 012, the third one is 023 and so on.

② DMX MODE

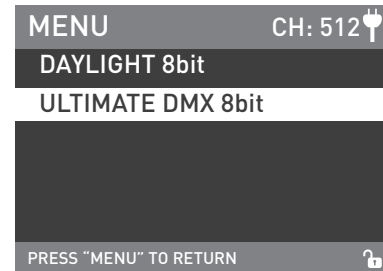
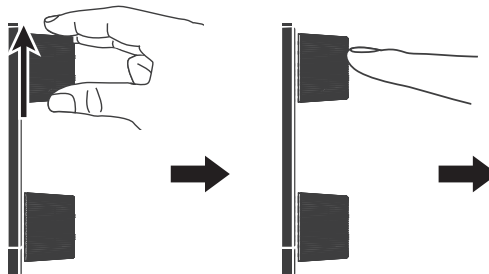
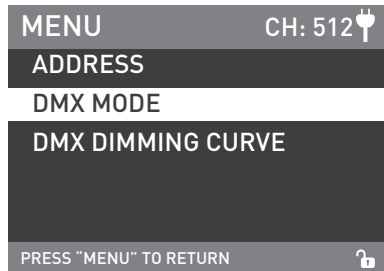

Rotate "Upper knob" to DMX MODE and press "Upper knob" to enter the corresponding secondary menu.

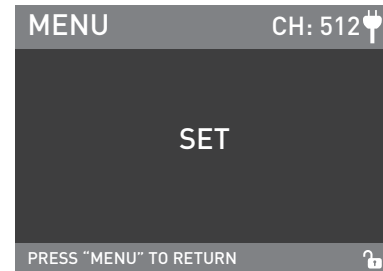
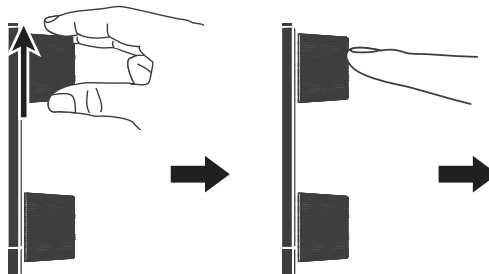
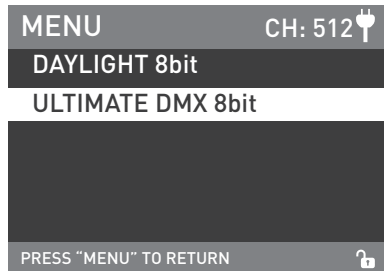

Rotate "Upper knob" to select DAYLIGHT 8bit or ULTIMATE DMX 8bit and press "Upper knob" to set.

③ DMX DIMMING CURVE

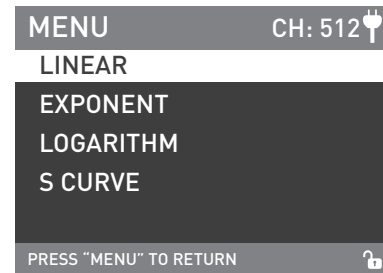
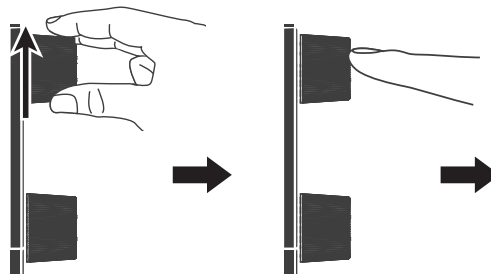
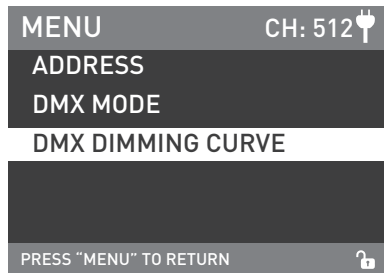

Rotate "Upper knob" to DMX DIMMING CURVE and press "Upper knob" to enter the corresponding secondary menu.

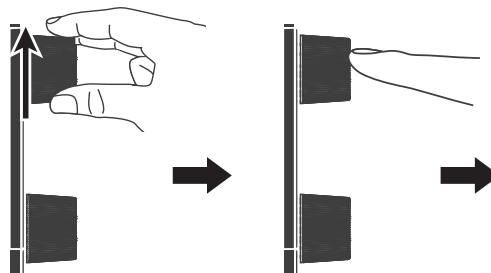
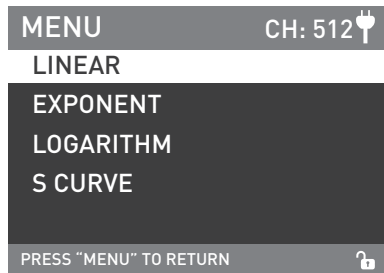

Rotate "Upper knob" to select the desired DMX DIMMING CURVE and press "Upper knob" to set.

2. DMX Remote Control

① Connect the light fixture and the DMX512 console by connection cable and the method is as below.



- The connection between the light fixture and DMX512 console, light fixture and light fixture should use five core shielded cable and make sure its diameter is not less than 0.3mm. XLR plug/socket and the wire should be connected as the picture above.
- Pin1, Pin2, Pin3 for connecting DMX signal, Pin4, Pin5 is connectionless.

▲ Note: When connect with socket, make sure the internal pin not be in contact with the inner case. The fixture can match the the DMX512 (1990) control signal.

- Plug of five-core and three-core XLR plug/socket conversion.

The fixture comes with five-core XLR plug. If you use the three-core XLR plug, kindly follow below instruction.

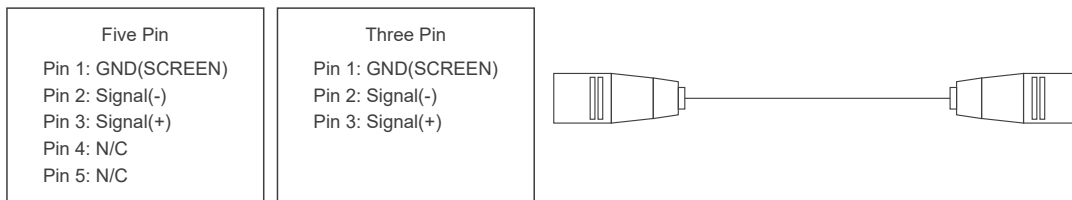

② DMX-in Port

In DMX mode, make sure the last light is the only light with a cable connected to DMX output. There is a resistance about 120(OHM) between the second pin and third pin of this plug (as shown).

Make sure this plug can be installed into the output of the last fixture, this will help avoid noise and reflection phenomenon caused by the DMX512 signal during the transmitting process.

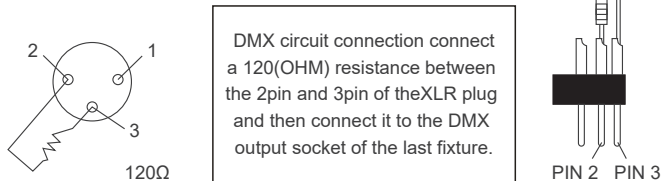

③ Set the address of the fixture.

④ Refer to the attached DMX reference guide and control the light via DMX512 console.

(For specific operation methods, please refer to the DMX512 console operation manual.)

Note: DMX Reference Guide « TK-200/TK-450 DMX Reference Guide (NANLUX)» please download from www.nanlux.com

3. 2.4G Remote Control

Set the address of the 2.4G remote controller to be consistent with the light fixture, then the light fixture can be remotely controlled by 2.4G remote controller or by APP via the 2.4G transfer device.

Note: ① 2.4G remote controller and 2.4G transfer device are sold separately.

② The fixture supports the 2.4G wireless protocol V1.0 and V2.0. Set fixture to V2.0 while using WS-RC-C1 or WS-RC-C2 remote control. Set fixture to V1.0 while using other remote controls.

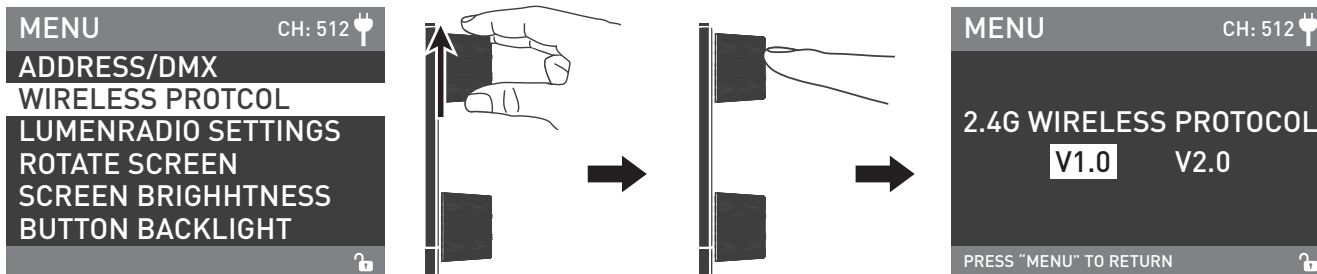

Rotate "Upper knob" to WIRELESS PROTOCOL and press "Upper knob" to enter the corresponding secondary menu.

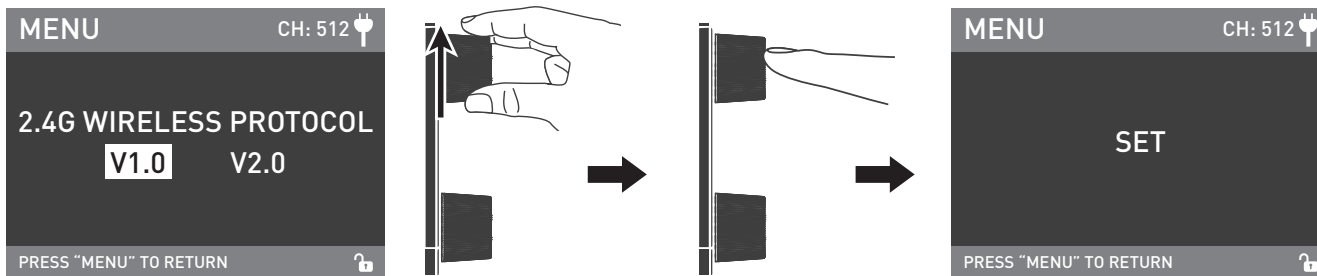

Rotate "Upper knob" to select V1.0 or V2.0 and press "Upper knob" to set.

4. RDM Remote Control

- ① Connect the light fixture to the console with RDM function using a connection cable, the connection method is the same as with a DMX512 console.
- ② Control the fixture via a console with RDM function.

(For specific operation methods, please refer to the RDM console operation manual.)

Note: The UID format of the fixture is as follows:

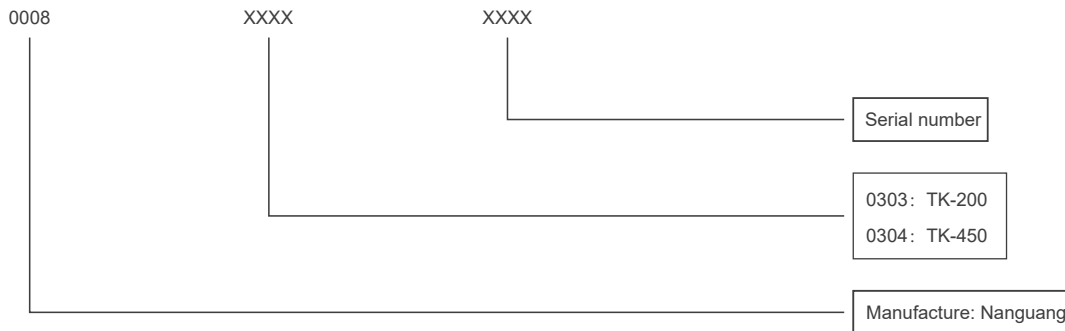

5. LUMENRADIO Remote Control

· TK series has built-in TIMO RX module, enabling it to receive CRMX wireless DMX signal. The operation method is as following:

- ① Set the fixture that need to receive CRMX wireless DMX signals to UNLINK.

Press the "MENU" Key to access options.

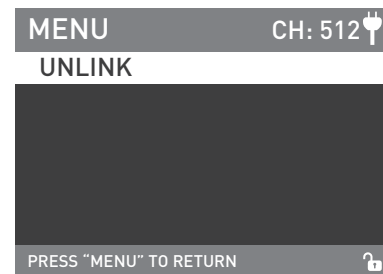
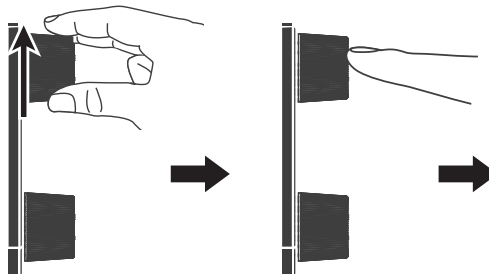
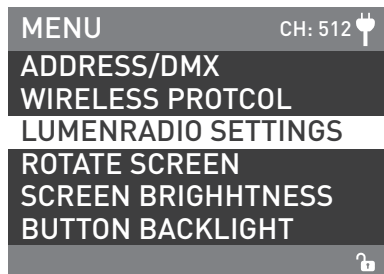
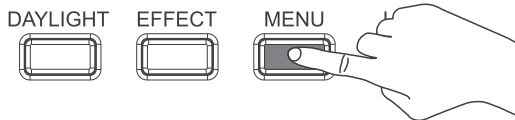
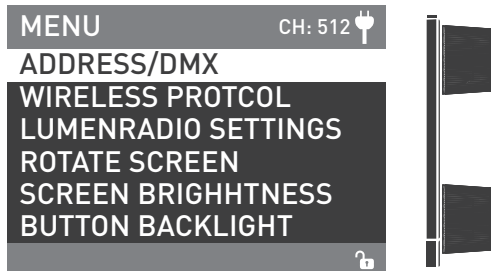

Rotate "Upper knob" to LUMENRADIO SETTINGS and press "Upper knob" to enter the corresponding secondary menu.

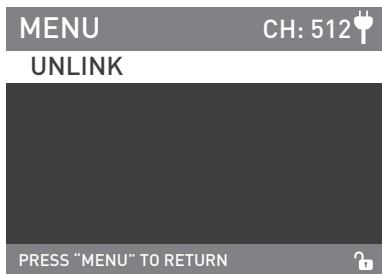

Rotate "Upper knob" to enter the next menu.

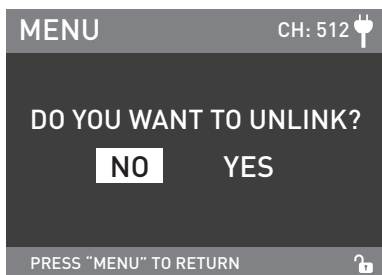
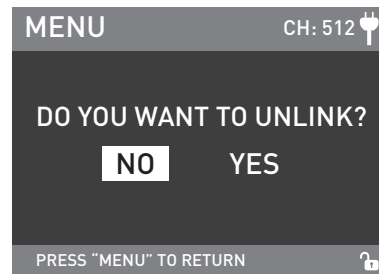
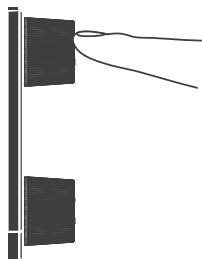

Rotate "Upper knob" to select YES and press "Upper knob" to set.

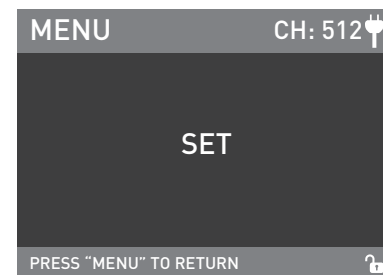
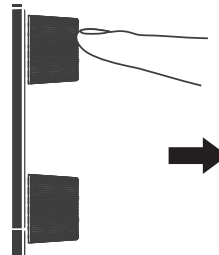
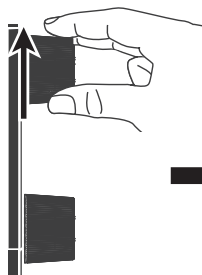

② Connect the fixture or CRMX wireless DMX transmitter set to TRANSMITTER MODE with the fixture needs to receive CRMX wireless DMX signals for remote control.

Note: The LUMENRADIO SETTINGS of the fixture should be set to UNLINK, then it could reconnected by a new fixture or transmitter.

Operation Instructions

1. Make sure the power switch is in the "off" position, then connect the fixture to the power supply with power cable. Then turn on the power switch, if the indicator is normally on, the screen will first display "NANLUX", that means the power is active.

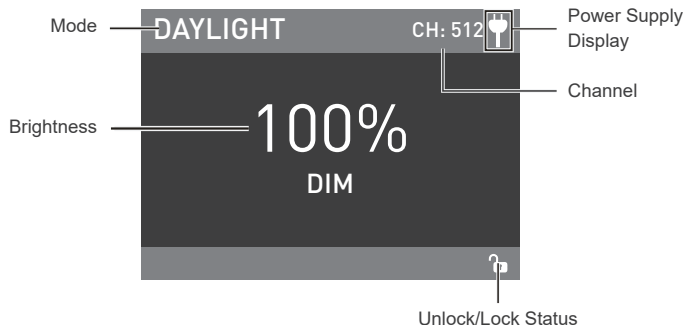

2. DAYLIGHT Key: Press the DAYLIGHT Key to enter the operation interface of DAYLIGHT mode. Rotate "Lower knob", clockwise to increase the brightness while counterclockwise to reduce the brightness. The display shows the percentage of the brightness, the DIM range is from the 0%-100%.

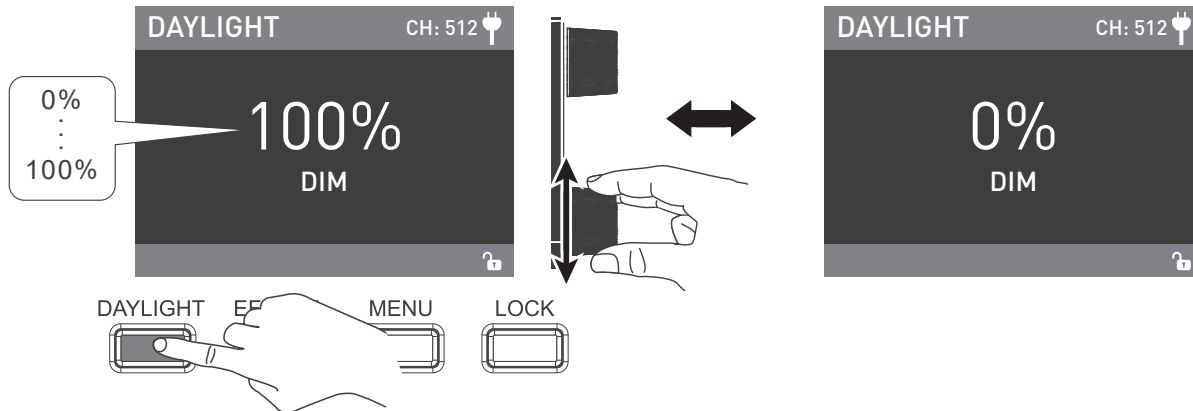

3. EFFECT Key: Press the Effect key to enter the operation interface of EFFECT mode, rotate "Lower knob" to select the desired special effect. TK-200/TK-450 has built-in special effects: INT LOOP, FLASH, PULSE, STORM AUTO, STORM MANUAL, TV, PAPARAZZI, CANDLE/FIRE, BAD BULB, FIREWORK, EXPLOSION AUTO, EXPLOSION MANUAL, WELDING.

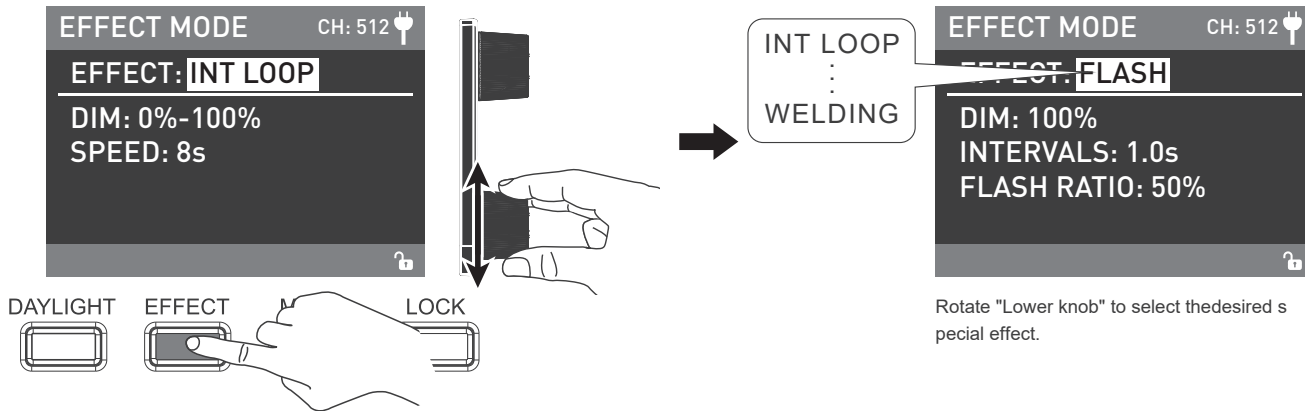

Rotate "Lower knob" to select the desired special effect.

① INT LOOP

For INT LOOP settings, rotate "Upper knob" to select DIM and SPEED (Range:2S-30S), then rotate "Lower knob" to set the corresponding parameters.

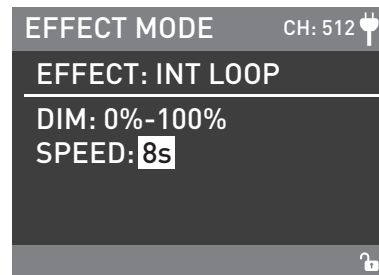
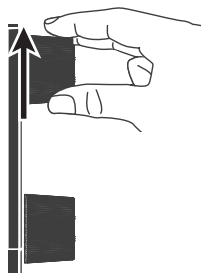
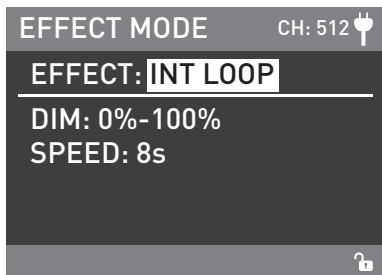

Rotate "Upper knob" to select DIM and SPEED.

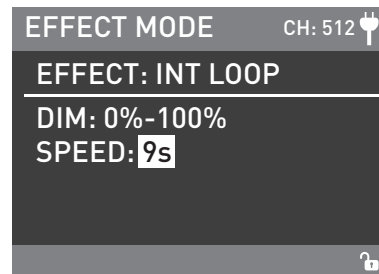
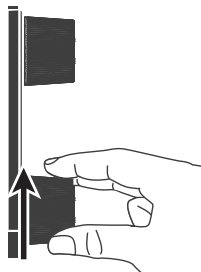
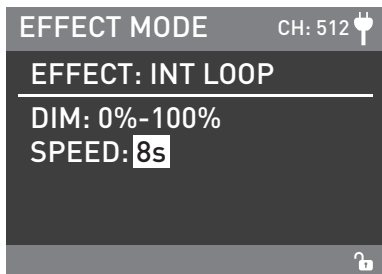

Rotate "Lower knob" to set corresponding parameters.

② FLASH

For FLASH settings, rotate "Upper knob" to select DIM, INTERVALS (Range:0.1s-10.0s) and FLASH RATIO (Range: 0% -100%), then rotate "Lower knob" to set the corresponding parameters.

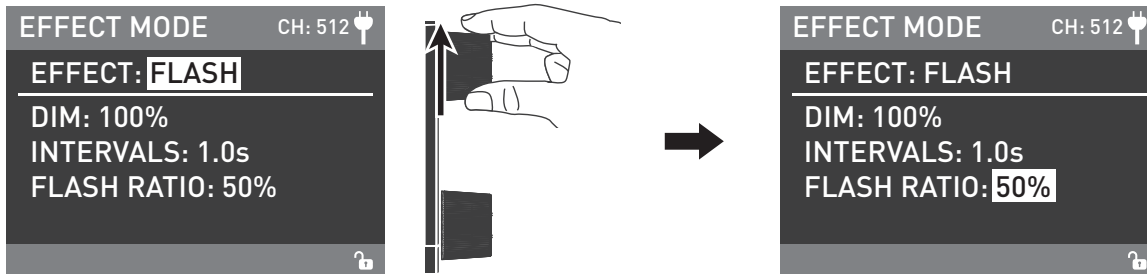

Rotate "Upper knob" to select DIM, INTERVALS and FLASH RATIO.

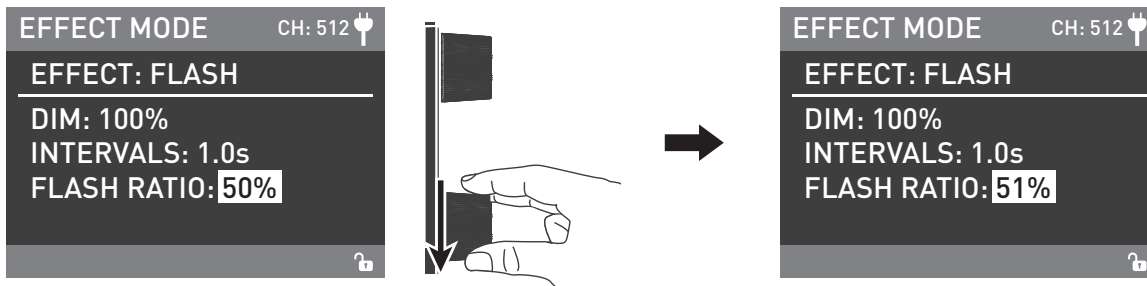

Rotate "Lower knob" to set the corresponding parameters.

③ PULSE

For PULSE settings, rotate "Upper knob" to select DIM and PULSES/MIN (Range:1-240), then rotate "Lower knob" to set the corresponding parameters.

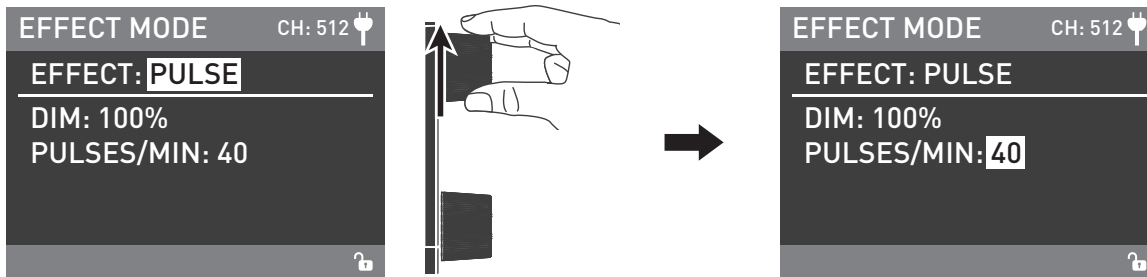

Rotate "Upper knob" to select DIM and PULSES/MIN.

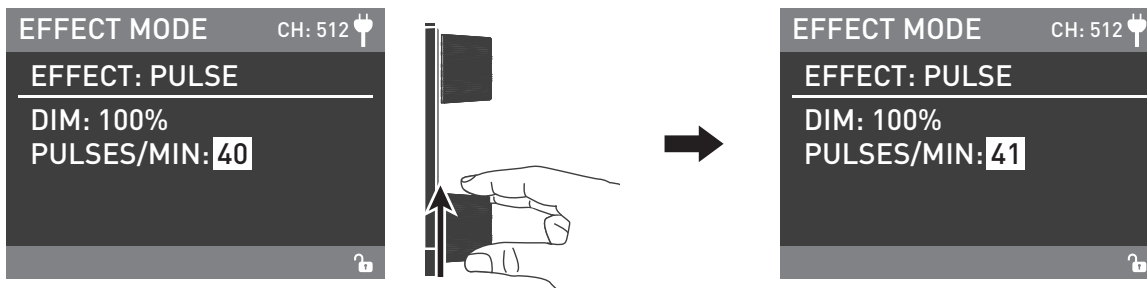

Rotate "Lower knob" to set the corresponding parameters.

④ STROM AUTO

For STROM AUTO settings, rotate "Upper knob" to select DIM, INTVL RANGE (Range: 1s-60s), then rotate "Lower knob" to set the corresponding parameters.

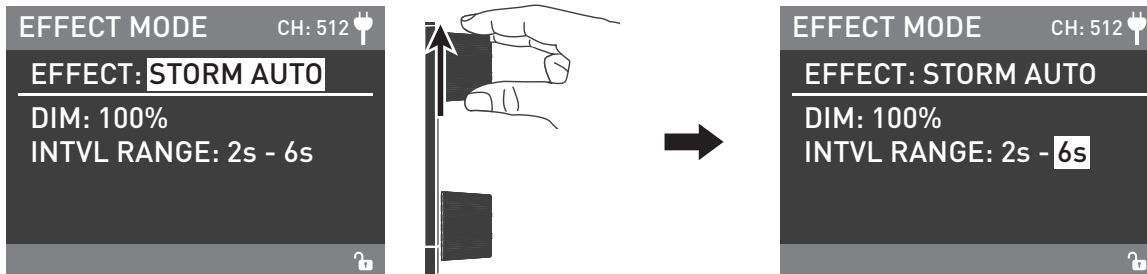

Rotate "Upper knob" to select the DIM, and INTVL RANGE.

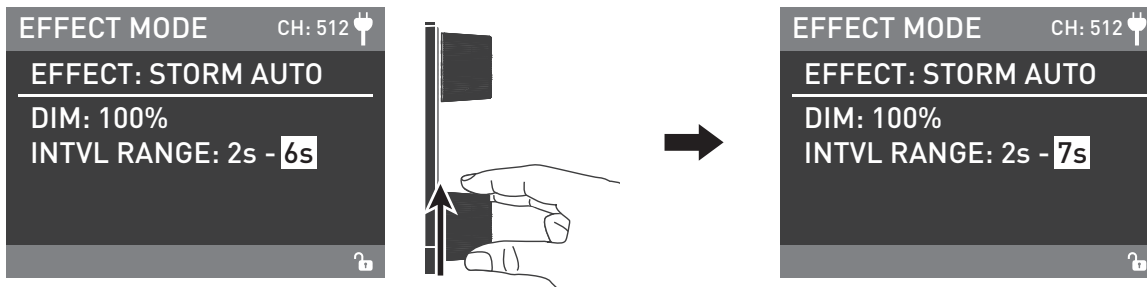

Rotate "Lower knob" to set the corresponding parameters.

⑤ STROM MANUAL

For STROM MANUAL settings, rotate "Upper knob" to select DIM, then rotate "Lower knob" to set the corresponding parameters and press "Upper knob" to trigger storm.

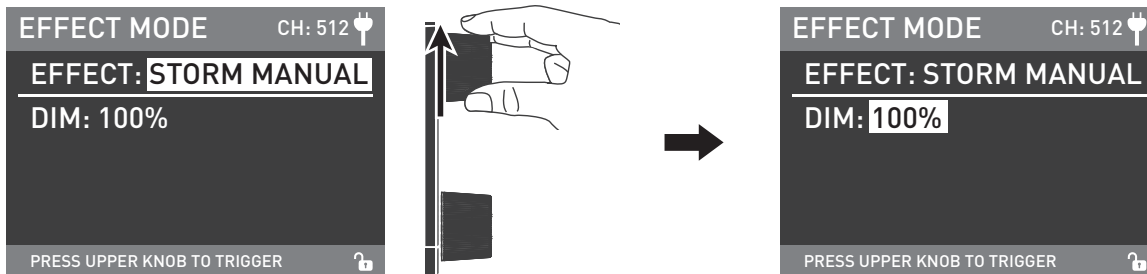

Rotate "Upper knob" to select DIM.

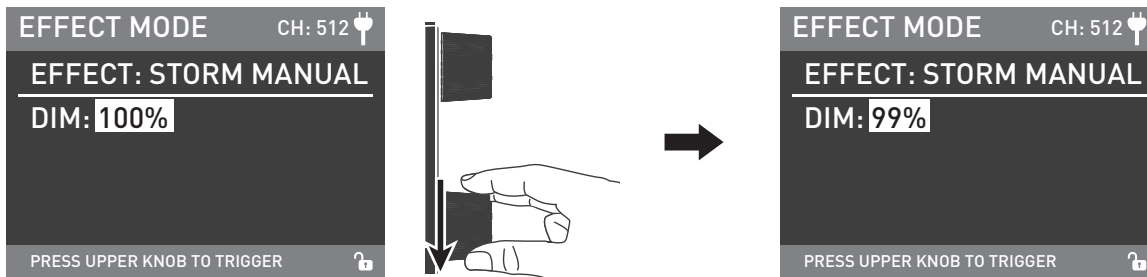

Rotate "Lower knob" to set the corresponding parameters.

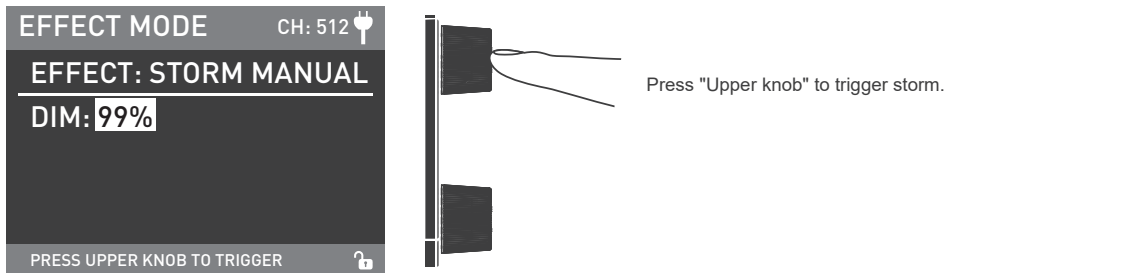

⑥ TV

For TV settings, rotate "Upper knob" to select DIM and SPEED (Range:1-100). Then rotate "Lower knob" to set the corresponding parameters.

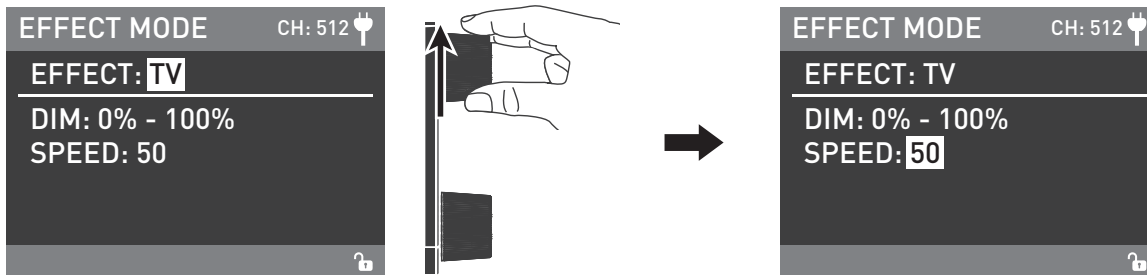

Rotate "Upper knob" to select the DIM and SPEED.

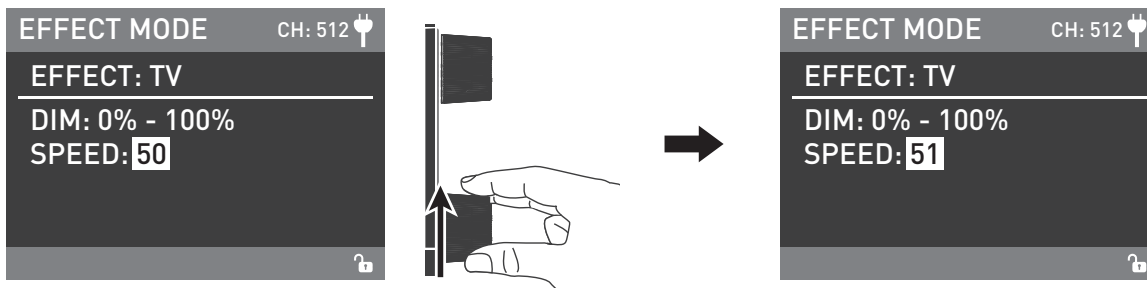

Rotate "Lower knob" to set the corresponding parameters.

⑦ PAPARAZZI

For PAPARAZZI settings, rotate the "Upper knob" to select DIM and SPEED (Range:1-100), then rotate "Lower knob" to set up the corresponding parameters.

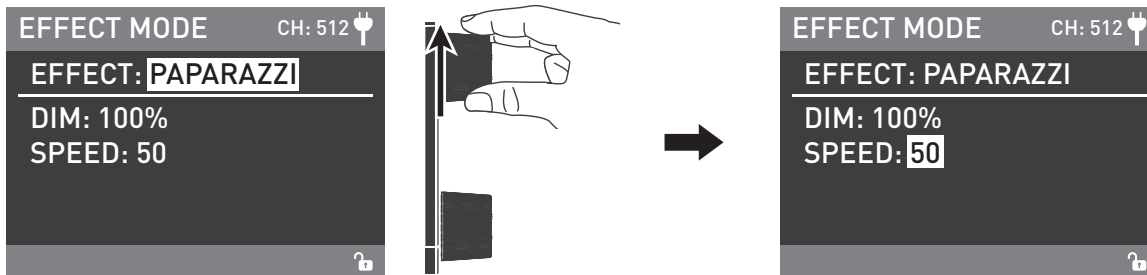

Rotate "Upper knob" to select the DIM and SPEED.

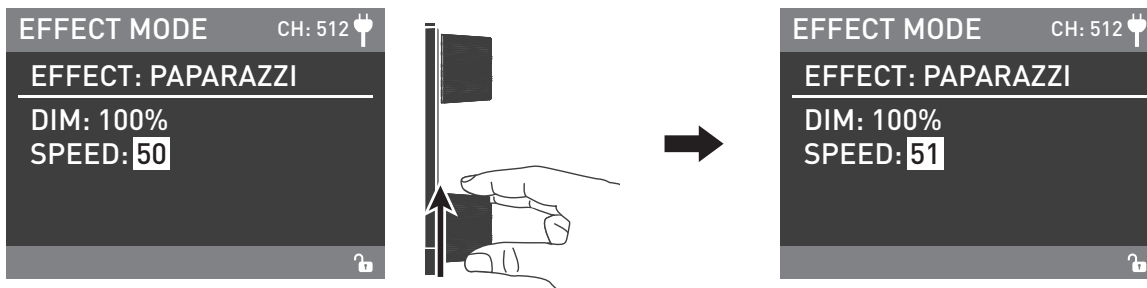

Rotate "Lower knob" to set the corresponding parameters.

⑧ PCANDLE/FIRE

For CANDLE/FIRE settings, rotate "Upper knob" to select DIM and SPEED (Range: 1-100), then rotate "Lower knob" to set the corresponding parameters.

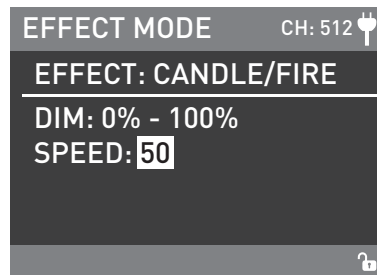
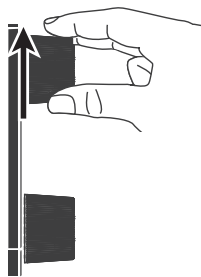
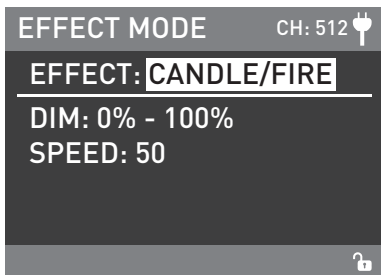

Rotate "Upper knob" to select the DIM and SPEED.

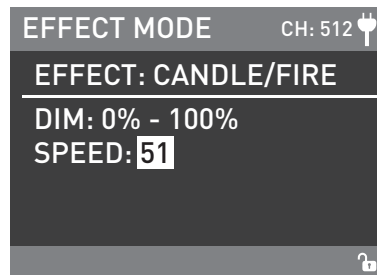
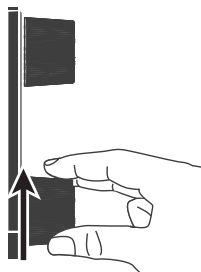
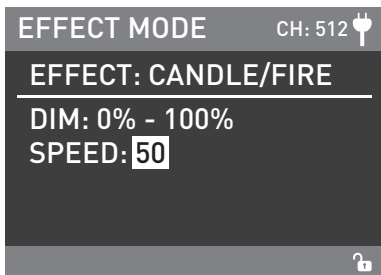

Rotate "Lower knob" to set the corresponding parameters.

⑨ BAD BULB

For BAD BULB settings, rotate "Upper knob" to select DIM, INTENSITY (Range:1-100) and SPEED (Range:1-100), then rotate "Lower knob" to set the corresponding parameters.

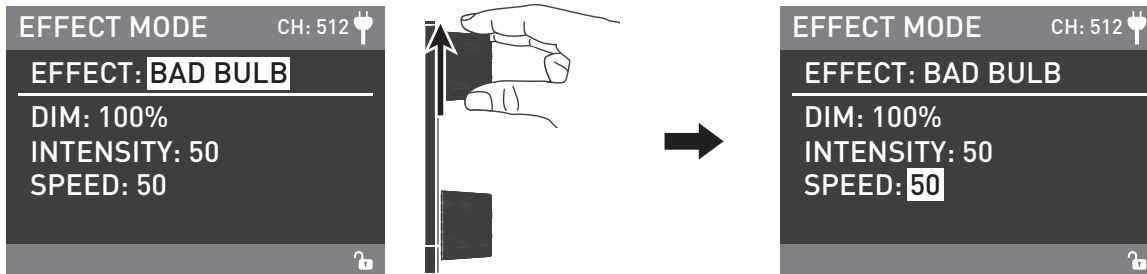

Rotate "Upper knob" to select DIM, INTENSITY and SPEED.

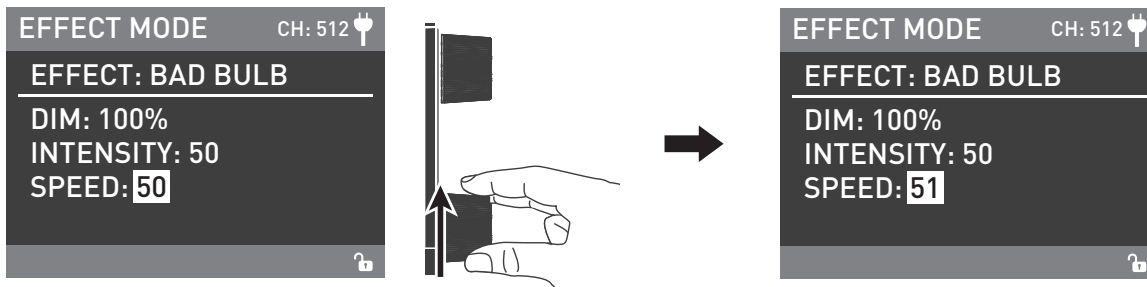

Rotate "Lower knob" to set the corresponding parameters.

⑩ FIREWORK

For FIREWORK settings, rotate "Upper knob" to select DIM and SPEED (Range: 1-100) and DECAY (Range:1-100), then rotate "Lower knob" to set the corresponding parameters.

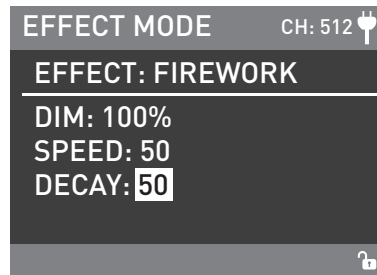
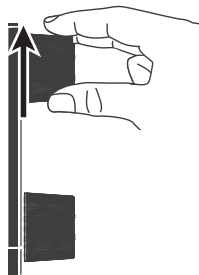
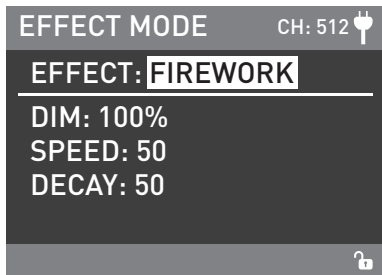

Rotate "Upper knob" to select DIM, SPEED and DECAY.

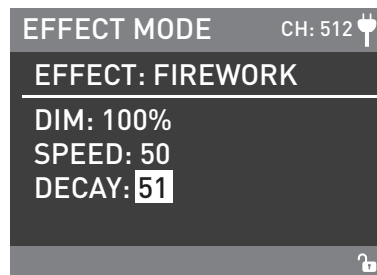
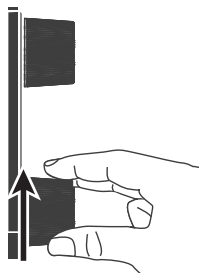
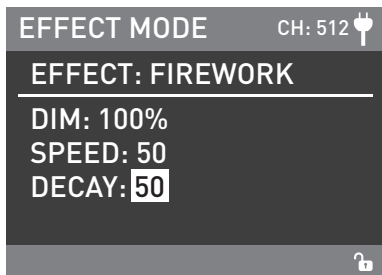

Rotate "Lower knob" to set the corresponding parameters.

⑩ EXPLOSION AUTO

For EXPLOSION AUTO settings, rotate "Upper knob" to select DIM, SPEED (Range:1-100) and DECAY (Range:1-100), then rotate "Lower knob" to set the corresponding parameters.

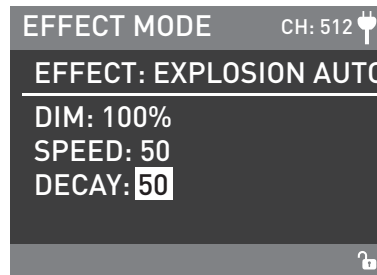
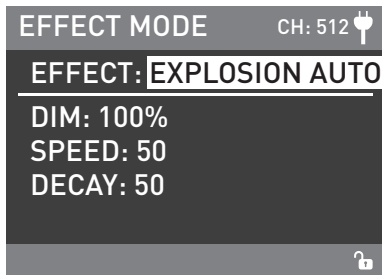

Rotate "Upper knob" to select DIM,SPEED and DECAY.

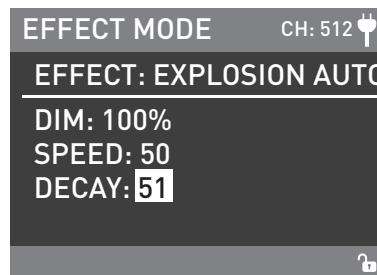
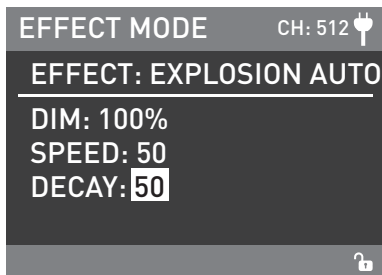

Rotate "Lower knob" to set the corresponding parameters.

⑫ EXPLOSION MANUAL

For EXPLOSION MANUAL settings, rotate "Upper knob" to select DIM and DECAY (Range:1-100), then rotate "Lower knob" to set the corresponding parameters.

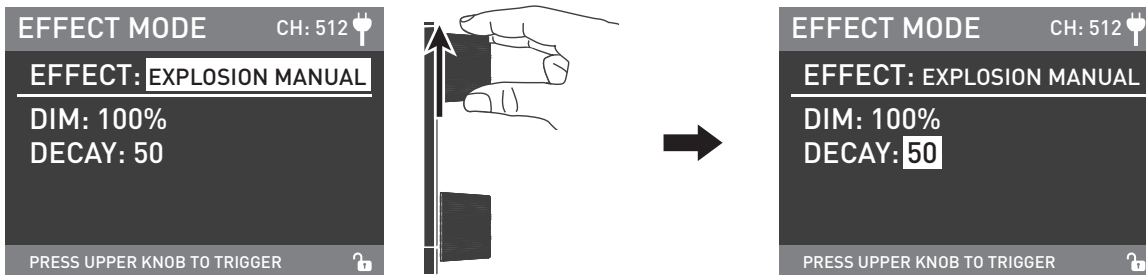

Rotate "Upper knob" to select DIM and DECAY.

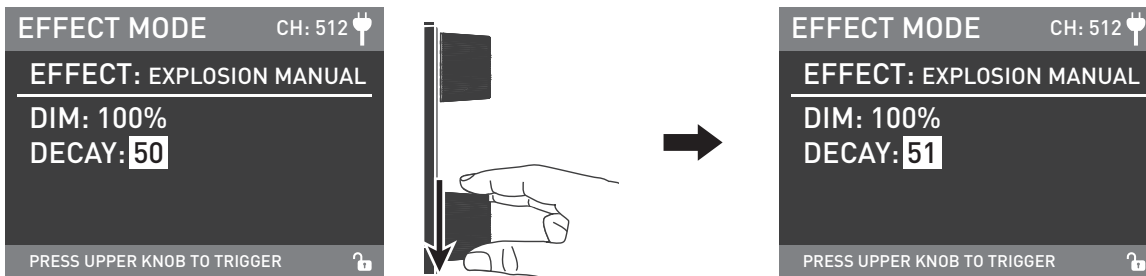

Rotate "Lower knob" to set the corresponding parameters.

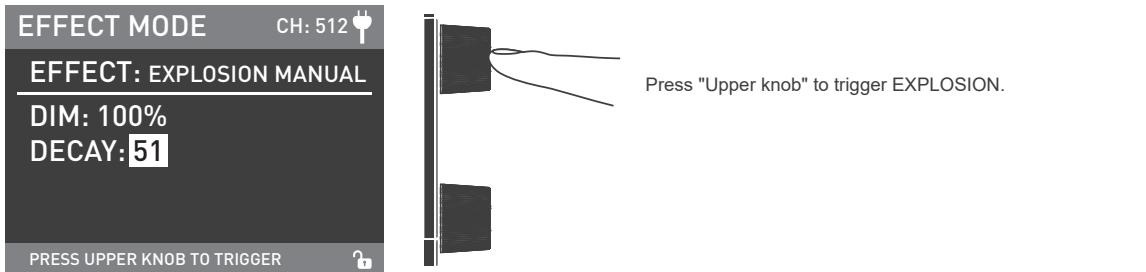

⑬ WELDING

For WELDING settings, rotate "Upper knob" to select DIM, SPEE (Range:1-100) and PAUSE (ON/OFF), then rotate "Lower knob" to set the corresponding parameters.

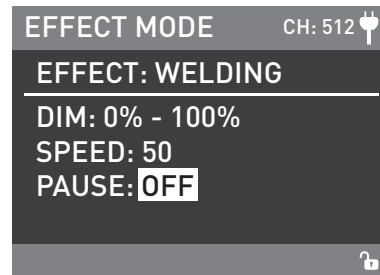
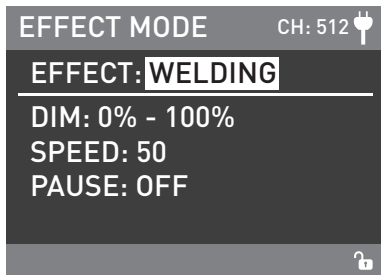

Rotate "Upper knob" to select DIM, SPEED and PAUSE.

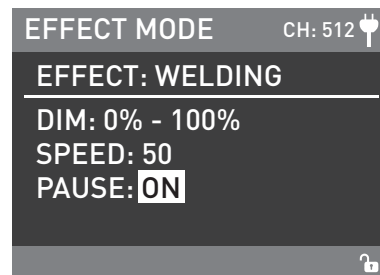
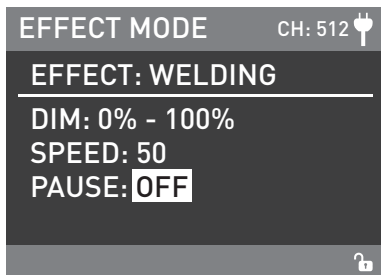

Rotate "Lower knob" to set the corresponding parameters.

Note: When the PAUSE is ON, WELDING paused.

- Lighting effects and additional functionality may be added with future firmware releases, for details of these please see www.nanlux.com.

4. MENU Key: Press MENU key to access options.

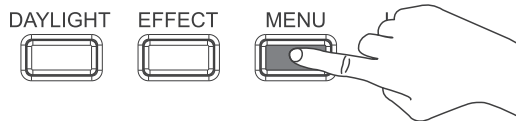
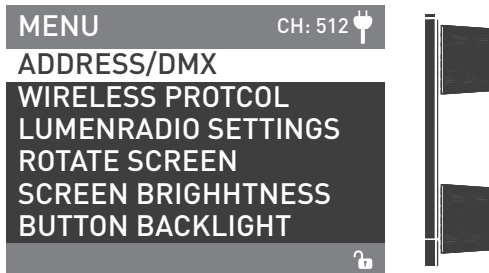

· Rotate "Upper knob" to select setting item, press "Upper knob" to enter corresponding secondary menu, rotate "Upper knob" again to select corresponding option, press "Upper knob" to set. Press MENU key to return to the previous menu.

① ADDRESS/DMX

For more operation details please refer to P5.

② WIRELESS PROTOCOL

For more operation details please refer to P10.

③ LUMENRADIO SETTINGS

For more operation details please refer to P12.

④ ROTATE SCREEN

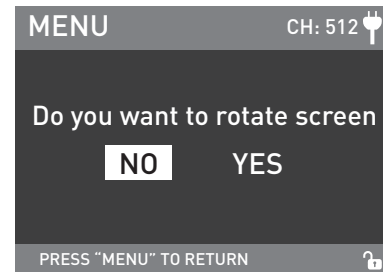
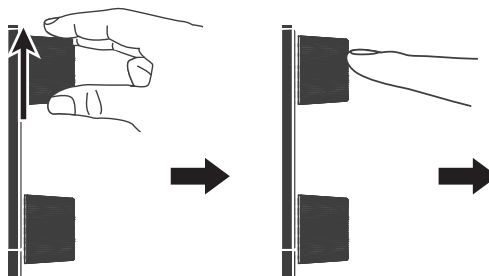
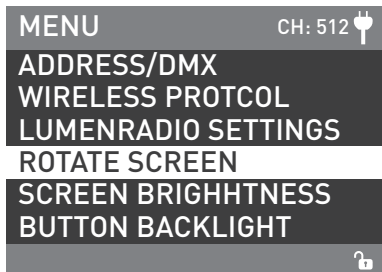

Rotate "Upper knob" to ROTATE SCREEN and press "Upper knob" to enter the corresponding secondary menu.

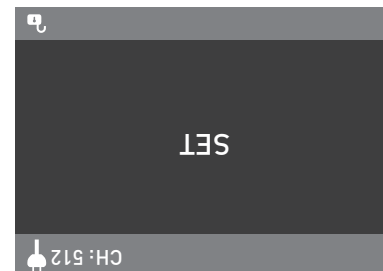
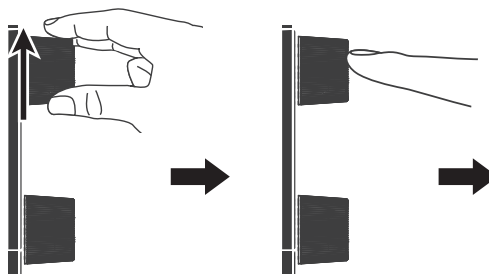
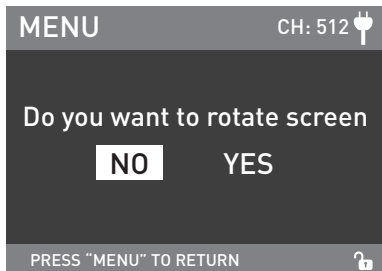

Rotate "Upper knob" to select YES or NO and press "Upper knob" to set.

⑤ SCREEN BRIGHTNESS

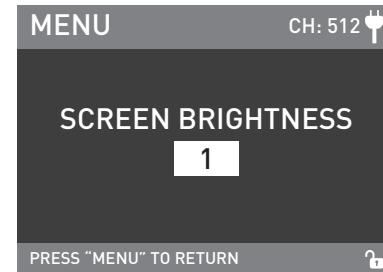
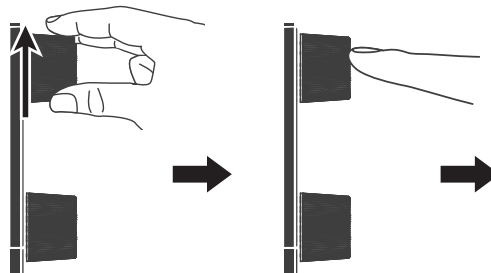
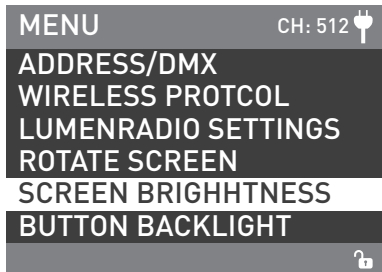

Rotate "Upper knob" to SCREEN BRIGHTNESS and press "Upper knob" to enter the corresponding secondary menu.

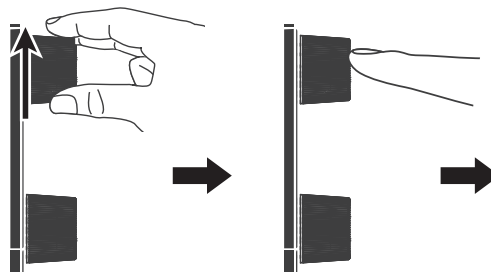
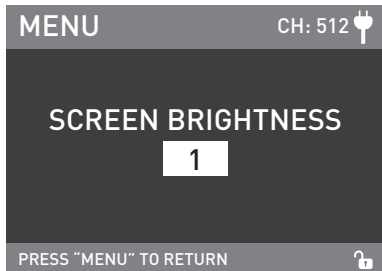

Rotate "Upper knob" to select the BRIGHTNESS and press "Upper knob" to set.

⑥ SCREEN BRIGHTNESS

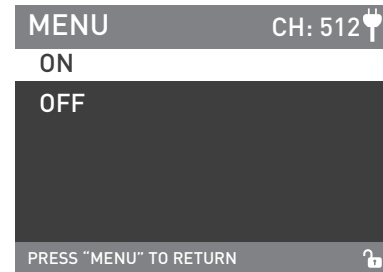
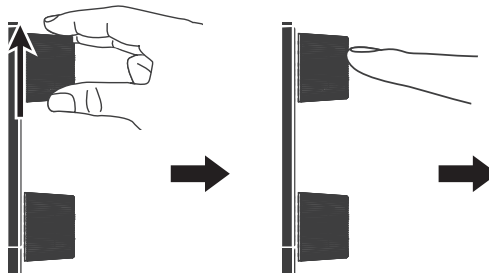
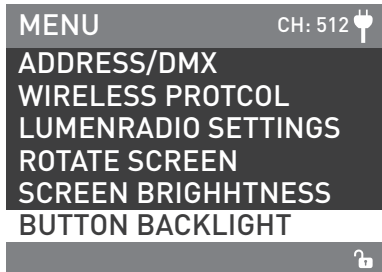

Rotate "Upper knob" to BUTTON BACKLIGHT and press "Upper knob" to enter the corresponding secondary menu.

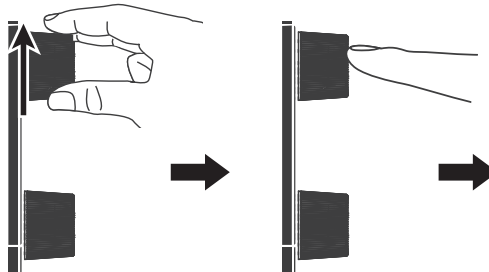
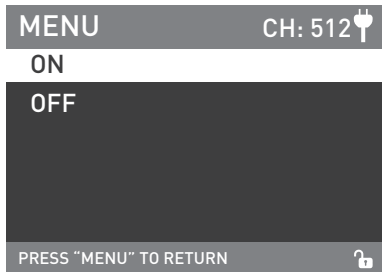

Rotate "Upper knob" to select ON or OFF and press "Upper knob" to set.

⑦ LANGUAGE

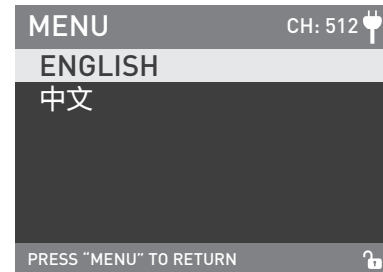
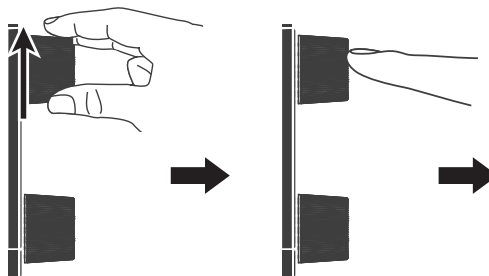
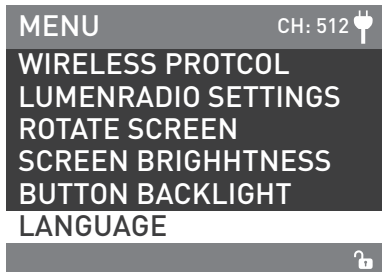

Rotate "Upper knob" to LANGUAGE and press "Upper knob" to enter the corresponding secondary menu.

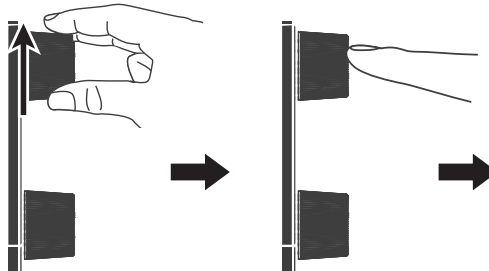
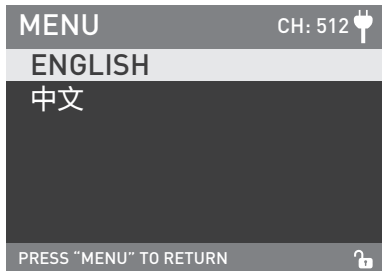

Rotate "Upper knob" to select ENGLISH or 简体中文 and press "Upper knob" to set.

Ⓢ VERSION

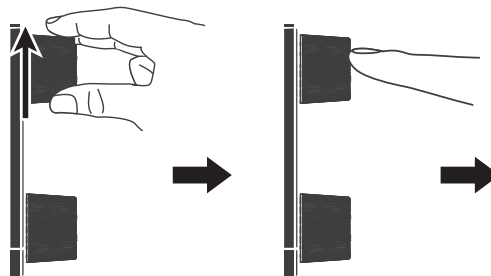
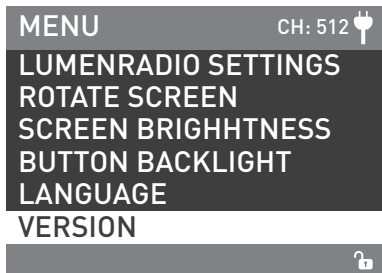

Rotate "Upper knob" to VERSION , and press "Upper knob" to check the current version.

5. Long press the LOCK Key to lock functions, now operation keys or adjustment knobs cannot change the current function, long press the Lock key again to release the Lock status.

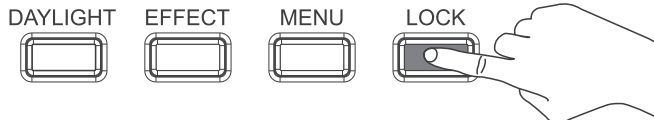
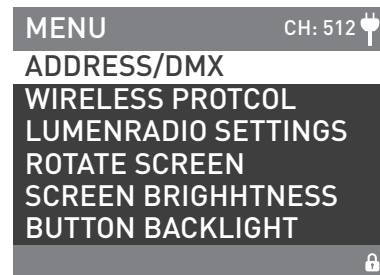
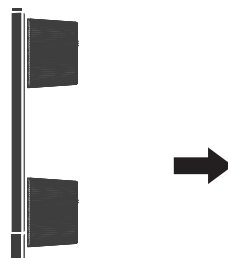
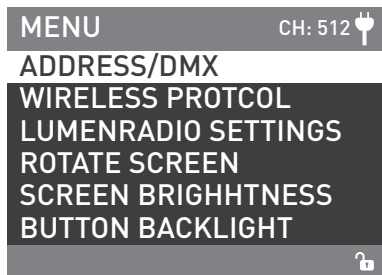

6. Turn off the power when not in use.

Safety Precautions

1. Please open the package to check for damage caused in transit, if damaged please do not use and contact place of purchase or manufacturer as soon as possible.
2. Do not use a power cable with damaged insulation. Do not unplug hard or drag the power cable directly.
3. Ensure the power supply's voltage matches the voltage specified by the fixture before installation.
4. When cleaning or not using the light, please turn it off.
5. Stored the light safely and away from children.





Notice



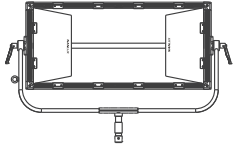
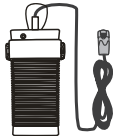

1. Do not place any object on the light emitter.
2. Don't place objects on the light or allow liquid to follow inside the fixture or the emitter.
3. Don't place the light near flammable substances like alcohol or gasoline.
4. When cleaning the light, please wipe off debris or dirt by using a dry cloth with clean water or neutral cleanser.
5. The light should be operated safely where it won't be at risk of getting wet or under extreme temperature.
6. Don't repair the light by yourself. Attempts to self repair will void warranty, for repairs please turn to place of purchase.
7. When using the fixture for a long time, the temperature of the fixture is high, please pay attention to anti-scalding.

General Fault Detection and Diagnosis

Fault Detection	Diagnosis
The light won't boot up properly!	<ol style="list-style-type: none"> 1. Please check the LED indicator. If flashing or not on at all, please check whether the connection between power adapter, power cable and outlet connection is properly connected or loose. 2. Please check whether the voltage value is within the specified parameters.
The fixture can operate by manual, but DMX control is not working.	<ol style="list-style-type: none"> 1. Please check whether the DMX original address setting of the fixture is correct or not. 2. Check that the XLR signal cable is connected correctly or is damaged.
LCD display is on, but can't operate the light.	Please check if the LCD display shows "🔒" long press the "LOCK" key to release the LOCK.
If the failure is not resolved after troubleshooting, please contact place of purchase.	

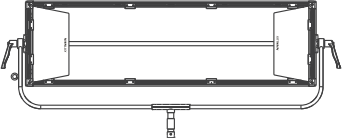
What's in the box? Please kindly check.

TK-200 x 1	Power Supply x 1	Power Cable x 1	DMX Reference Guid x 1	User Manual x 1
				

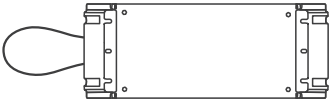
TK-450 x 1	Connecting Cable x 1	Power Cable x 1	DMX Reference Guid x 1	User Manual x 1
				
Power Supply x 1				
				

This manual and all stats within it were produced under controlled conditions, and are accurate at time of print. Further details about design or technical data updated please visit www.nanlux.com.

Version: V4 2021-04-29

 +86-754-85751187

 +86-754-85300887

 info@nanlux.com

 Zhanglin,324,Dongli Chenghai Shantou Guangdong China

Guangdong NanGuang Photo&Video Systems Co., Ltd