

*USER MANUAL*

**NANLUX**

INNOVATE · ILLUMINATE

***TK-140B/TK-280B***

***LED BI-COLOR SOFT PANEL LIGHT***

[WWW.NANLUX.COM](http://WWW.NANLUX.COM)

# Contents

<b>Product Diagram</b> .....	01		
<b>Technical Data</b> .....	01		
<b>Product Details</b> .....	02		
<b>Detailed Description</b> .....	03		
<b>Power Connection</b> .....	04		
<b>Remote Control</b>			
1. ADDRESS/DMX .....	07		
2. DMX Remote Control .....	10		
3. 2.4G Remote Control .....	12		
4. RDM Remote Control .....	13		
5. LUMENRADIO Remote Control .....	14		
<b>Operating Instructions</b>			
1. Screen Interface Display Instructions .....	16		
2. CCT Key .....	16		
3. EFFECT Key .....	18		
		4. MENU Key .....	33
		①OUTPUT MODE .....	33
		②ADDRESS/DMX .....	34
		③WIRELESS PROTOCOL .....	34
		④LUMENRADIO SETTINGS .....	34
		⑤ROTATE SCREEN .....	35
		⑥SCREEN BRIGHTNESS .....	36
		⑦BUTTON BACKLIGHT .....	37
		⑧LANGUAGE .....	38
		⑨VERSION .....	39
		5. LOCK Key .....	39
		<b>Safety Precautions</b> .....	40
		<b>Notice</b> .....	40
		<b>General Fault Detection and Diagnosis</b> .....	40
		<b>Product Includes</b> .....	41

# TK-140B/TK-280B LED Bi-color Soft Panel Light

## Product Diagram

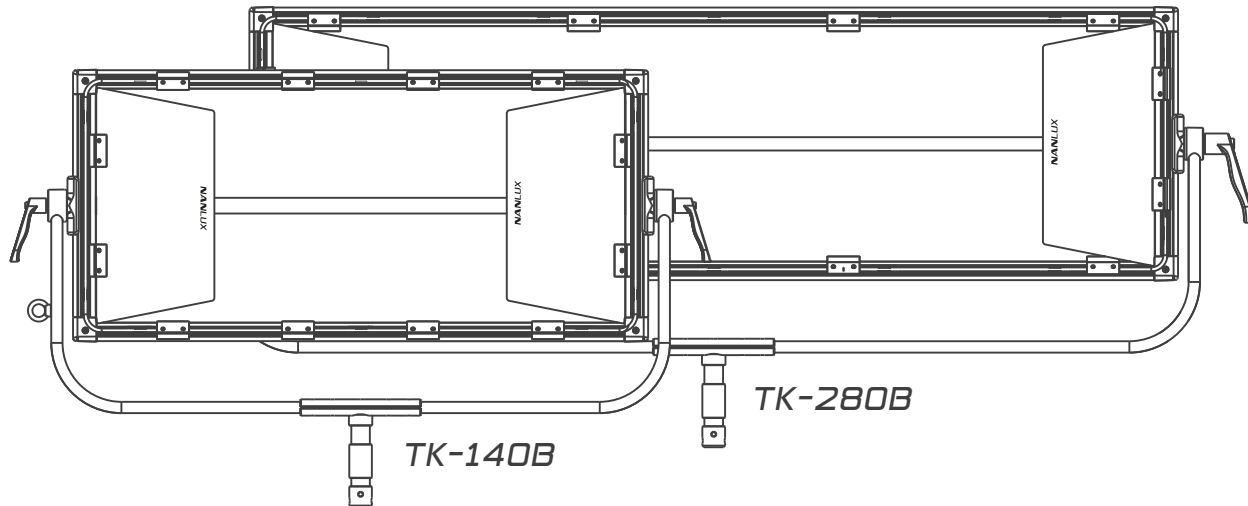

## Technical Data

### Model No.: TK-140B

Rated power: 160W

Input voltage/current: DC24V/6.67A Max

AC100-240V 50/60Hz

CCT: 2700K - 7500K

CRI: Average 95

TLCI: Average 98

### Model No.: TK-280B

Rated power: 280W

Input voltage/current: DC48V/5.84A Max

AC100-240V 50/60Hz

CCT: 2700K - 7500K

CRI: Average 95

TLCI: Average 98

Product Details

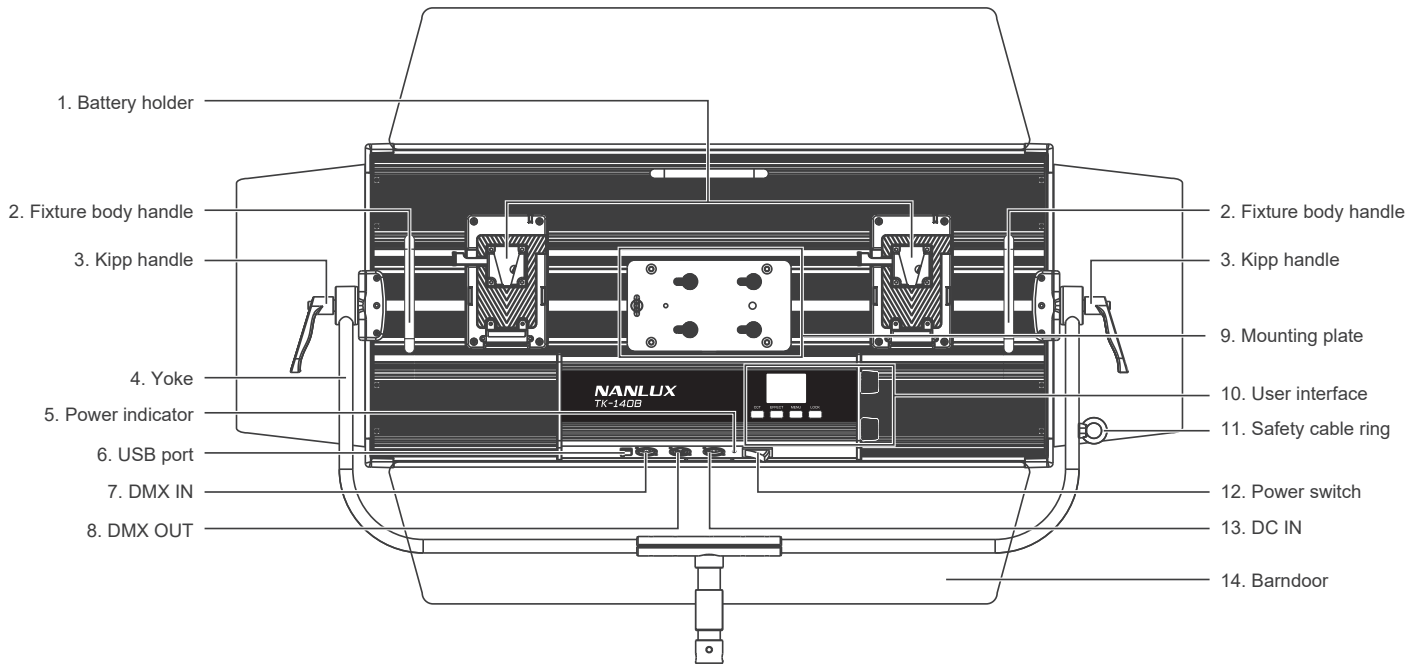



## Detailed Description

1. Battery holder: For installing the 14.4-26V/12A V-mount battery or the power supply.
2. Fixture body handle: For lift the fixture and adjust the direction of the fixture.
3. Kipp handle: Tighten or release the tilt movement of the fixture on the yoke.
4. Yoke: Mount the fixture on a stand; pan and tilt.
5. Power indicator: Check the status of the power input. Indicator always on: normal power supply; Indicator flashing or off: abnormal power supply or no power input.
6. USB port: Install firmware updates.
7. DMX IN: DMX signal input interface.
8. DMX OUT: DMX signal output interface.
9. Mounting plate: For installing gooseneck base or 5/8 pin base.
10. User interface: Display and control functions, operations and data.
11. Safety cable ring: Attach safety rope to secure the diffuser.
12. Power switch: Turn on/off the fixture.
13. DC IN: DC power Input interface.
14. Barndoor: For controlling the spill of light.

## Power Connection

1. Connection between the light fixture and power supply

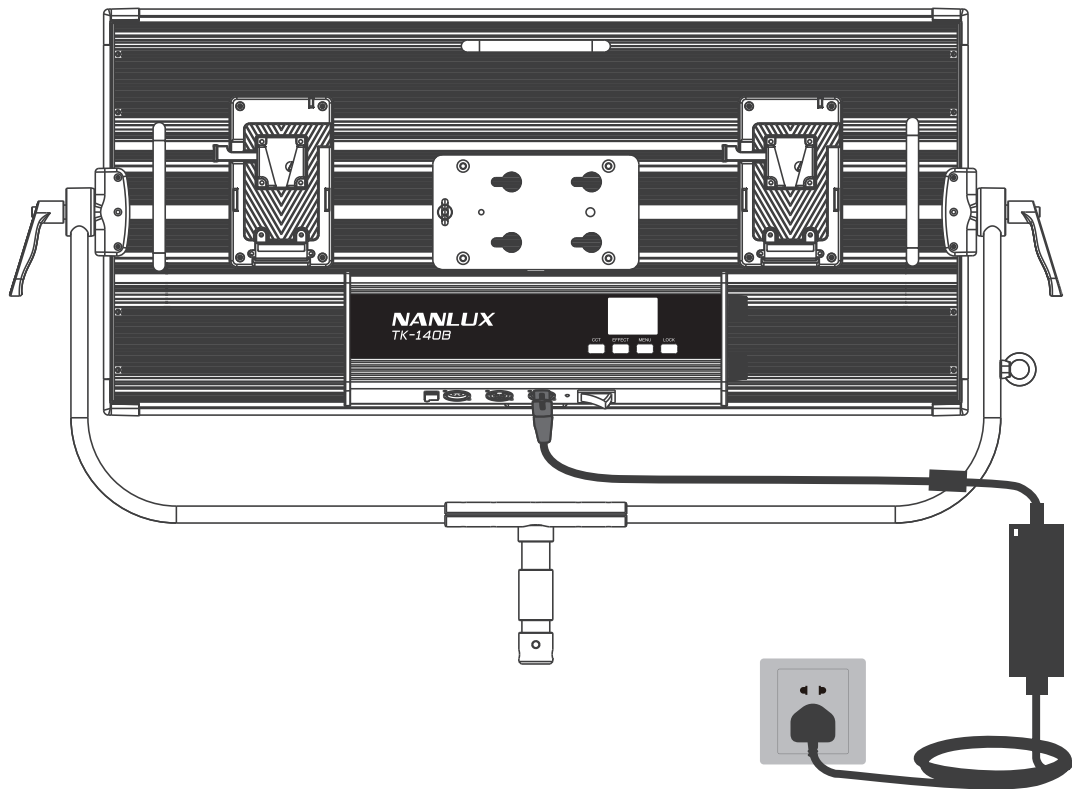

**NOTE:**

- ① When connecting the power supply, please make sure the power voltage and frequency is consistent with the provided power supply.
- ② Make sure to use the provided power supply and power cable. The connection between plug on power supply and the power cable on the fixture should be connected as following.

· TK-140B



DC IN

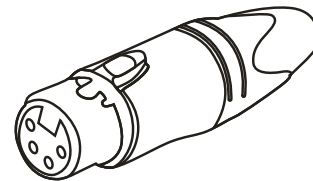
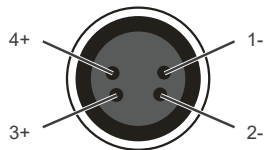

· TK-280B

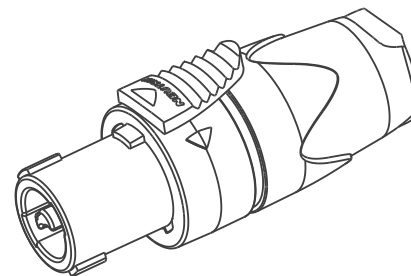
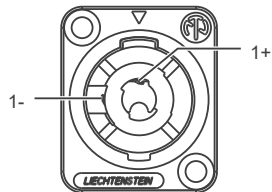
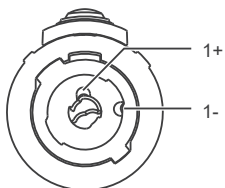

2. Connection between the light fixture and battery

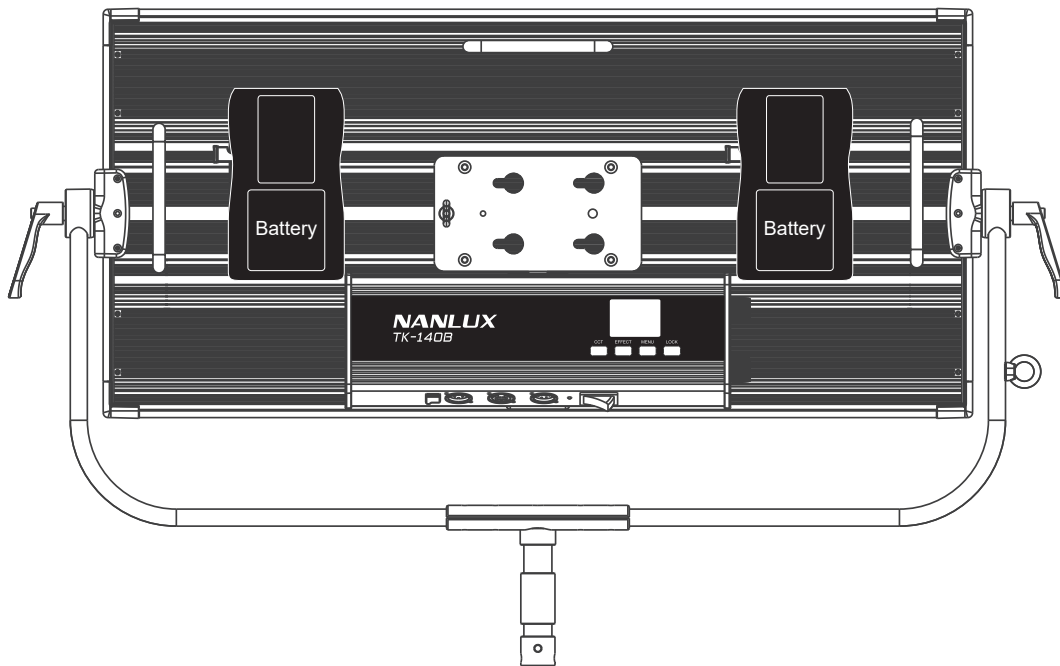

- ① TK-140B can be powered by one or two 14.8V batteries, or powered by one or two 26V batteries. The max power output is 75% when powered by one 14.8V battery.
- ② TK-280B can be powered by two 14.8V batteries, or powered by one or two 26V batteries, The max power output is 75% when powered by one 26V battery.
- ③ Please do not power the fixture with 14.8V and 26V batteries at the same time.
- ④ If there are much differences in current battery level between the two batteries and the two batteries cannot supply power at the same time, the max power output will be reduced to 75%
- ⑤ The battery is sold separately.

## Remote Control

· TK-140B/TK-280B supports remote control via DMX, 2.4G, RDM, LUMENRADIO, and has built-in bluetooth.

▲The ADDRESS needs to be set before operating the remote control via DMX, 2.4G, RDM and LUMENRADIO.

1. ADDRESS/DMX, including ADDRESS, DMX MODE and DMX DIMMING CURVE setting.

### ① ADDRESS

Press MENU key to access options.

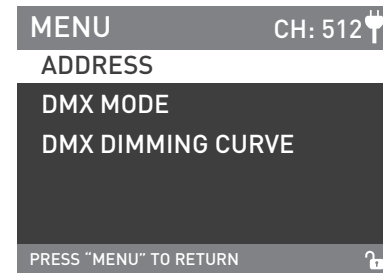
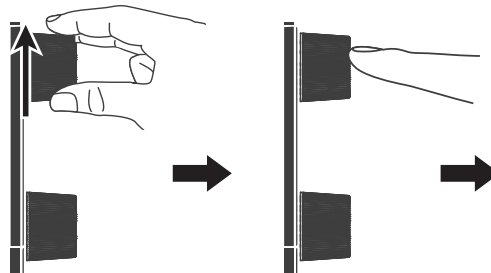
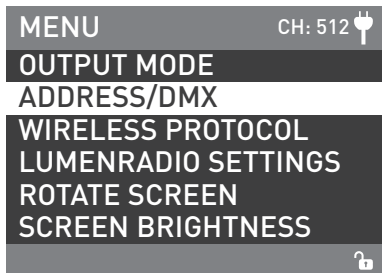
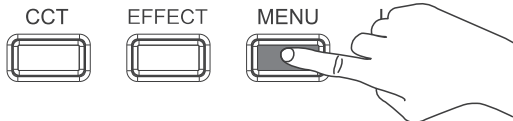
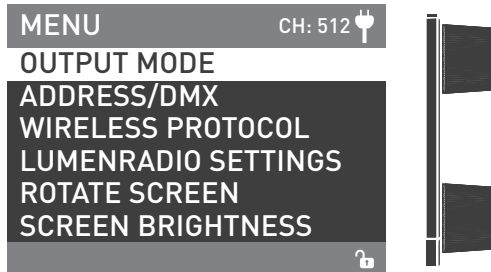

Rotate "Upper knob" to select ADDRESS and press "Upper knob" to enter the corresponding secondary menu.

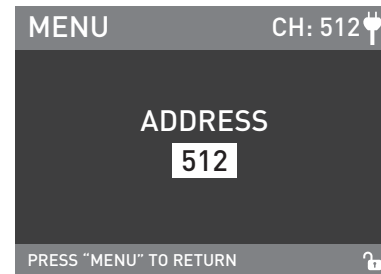
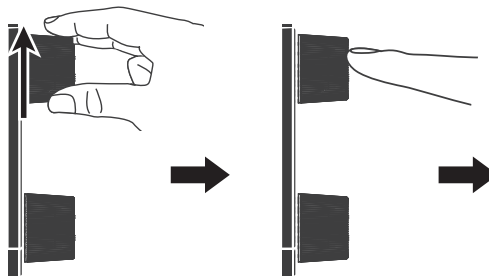
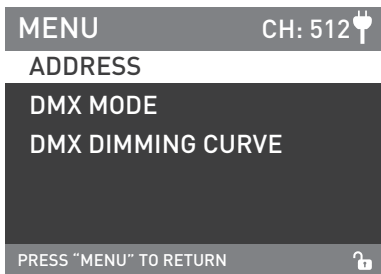

Rotate "Upper knob" to ADDRESS and press "Upper knob" to enter corresponding third menu.

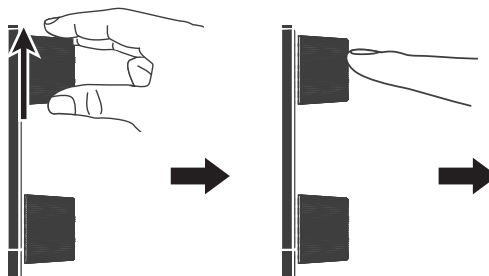
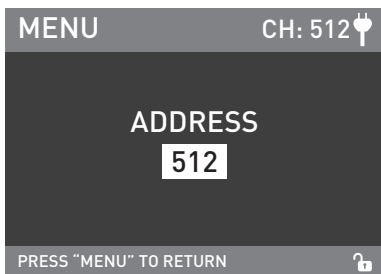

Rotate "Upper knob" to select the ADDRESS and press "Upper knob" to set.

NOTE: TK-140B/TK-280B has 10 channels, for multiple lights remote control via DMX, 2.4G, RDM, LUMENRADIO, the address of the first light is set to 001, the second one is 012, the third one is 023 and so on.

② DMX MODE

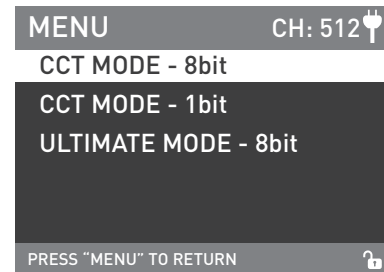
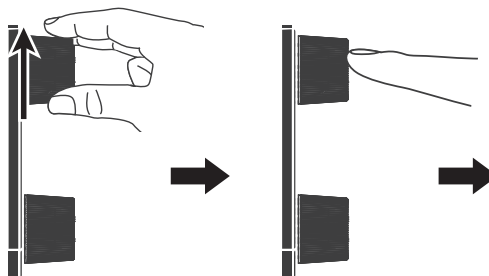
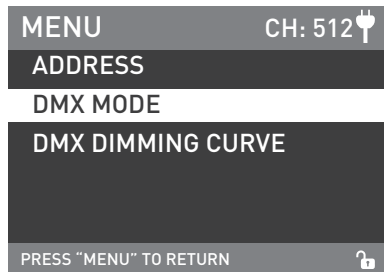

Rotate "Upper knob" to DMX MODE and press "Upper knob" to enter the corresponding secondary menu.

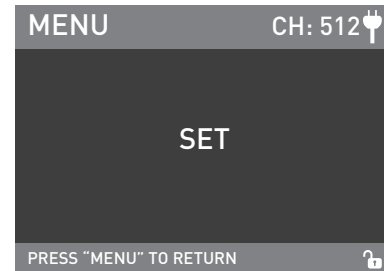
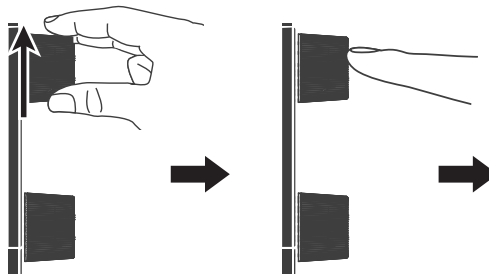
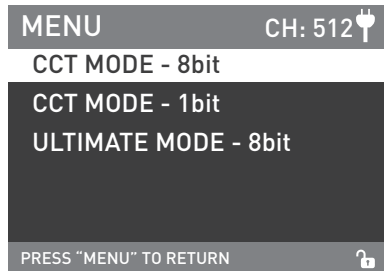

Rotate "Upper knob" to select the desired DMX MODE and press "Upper knob" to set.

③ DMX DIMMING CURVE

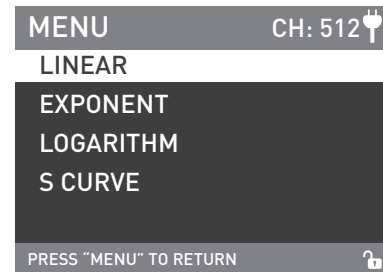
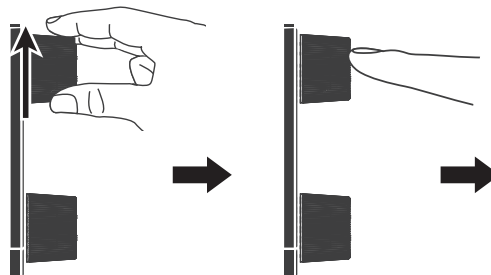
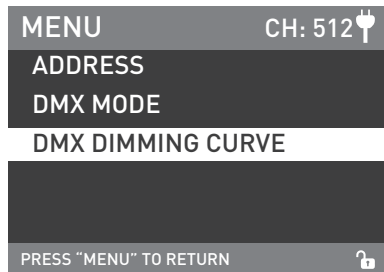

Rotate "Upper knob" to DMX DIMMING CURVE and press "Upper knob" to enter the corresponding secondary menu.

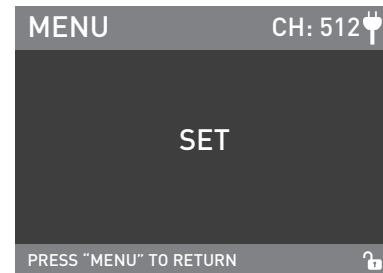
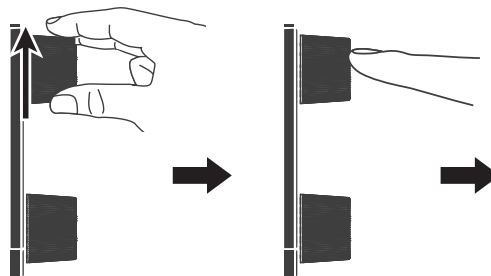
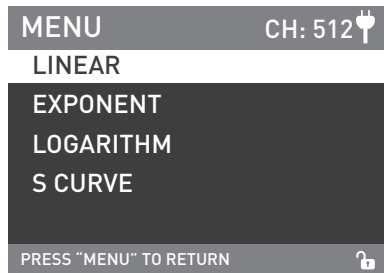

Rotate "Upper knob" to select the desired DMX DIMMING CURVE and press "Upper knob" to set.

2. DMX Remote Control

① Connect the light fixture and the DMX512 console by connection cable and the method is as below.





- The connection between the light fixture and DMX512 console, light fixture and light fixture should use five core shielded cable and make sure its diameter is not less than 0.3mm. XLR plug/socket and the wire should be connected as the picture above.
- Pin1, Pin2, Pin3 for connecting DMX signal, Pin4, Pin5 is connectionless.

▲ Note: When connect with socket, make sure the internal pin not be in contact with the inner case. The fixture can match the the DMX512 (1990) control signal.

- Plug of five-core and three-core XLR plug/socket conversion.

The fixture comes with five-core XLR plug. If you use the three-core XLR plug, kindly follow below instruction.

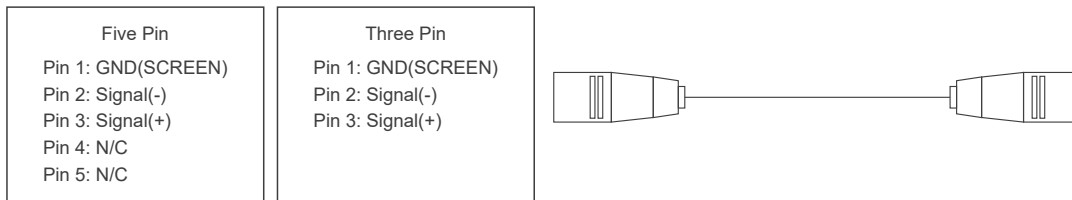

② DMX-in Port

In DMX mode, make sure the last light is the only light with a cable connected to DMX output. There is a resistance about 120(OHM) between the second pin and third pin of this plug (as shown).

Make sure this plug can be installed into the output of the last fixture, this will help avoid noise and reflection phenomenon caused by the DMX512 signal during the transmitting process.

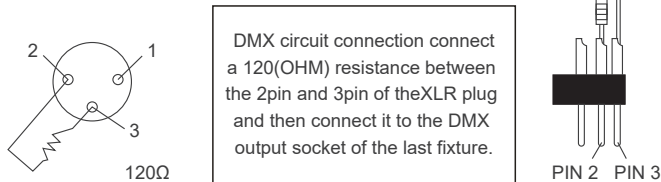

③ Set the address of the fixture.

④ Refer to the attached DMX reference guide and control the light via DMX512 console.

(For specific operation methods, please refer to the DMX512 console operation manual.)

Note: DMX Reference Guide «TK-140B/TK-280B DMX Reference Guide (NANLUX)» please download from [www.nanlux.com](http://www.nanlux.com)

### 3. 2.4G Remote Control

Set the address of the 2.4G remote controller to be consistent with the light fixture, then the light fixture can be remotely controlled by 2.4G remote controller or by APP via the 2.4G transfer device.

Note: ① 2.4G remote controller and 2.4G transfer device are sold separately.

② The fixture supports the 2.4G wireless protocol V1.0 and V2.0. Set fixture to V2.0 while using WS-RC-C1 or WS-RC-C2 remote control. Set fixture to V1.0 while using other remote controls.

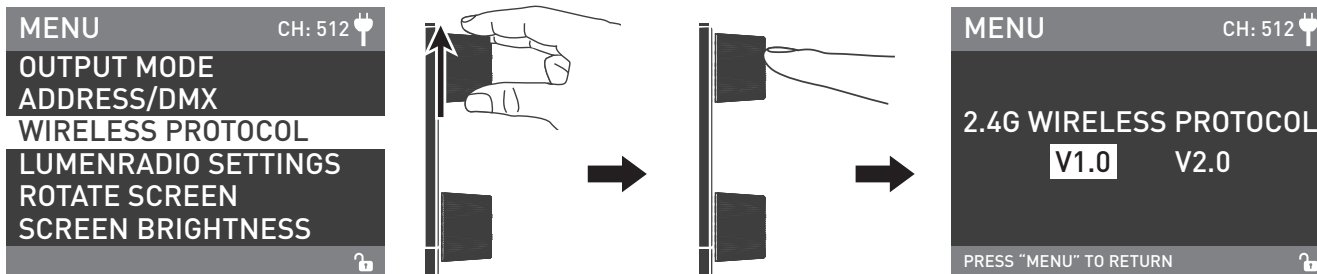

Rotate "Upper knob" to WIRELESS PROTOCOL and press "Upper knob" to enter the corresponding secondary menu.

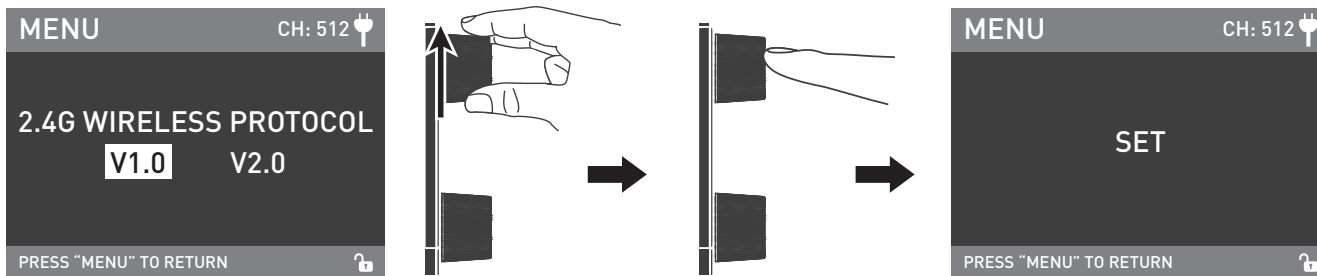

Rotate "Upper knob" to select V1.0 or V2.0 and press "Upper knob" to set.

4. RDM Remote Control

- ① Connect the light fixture to the console with RDM function using a connection cable, the connection method is the same as with a DMX512 console.
- ② Control the fixture via a console with RDM function.

(For specific operation methods, please refer to the RDM console operation manual.)

Note: The UID format of the fixture is as follows:

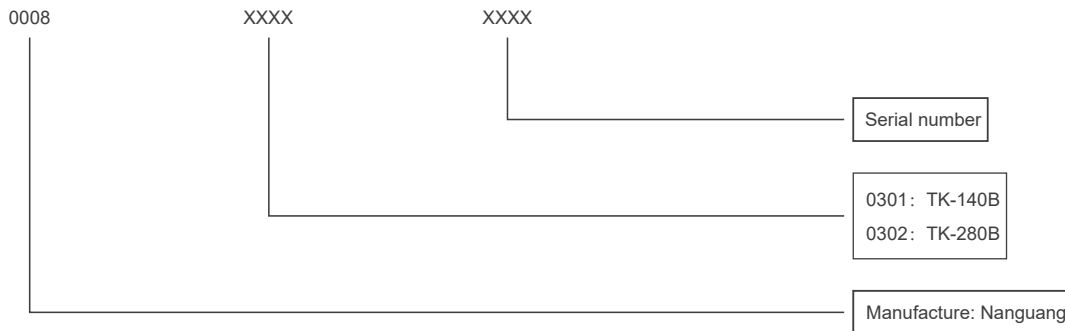

5. LUMENRADIO Remote Control

· TK series has built-in TIMO RX module, enabling it to receive CRMX wireless DMX signal. The operation method is as following:

- ① Set the fixture that need to receive CRMX wireless DMX signals to UNLINK.

Press the "MENU" Key to access options.

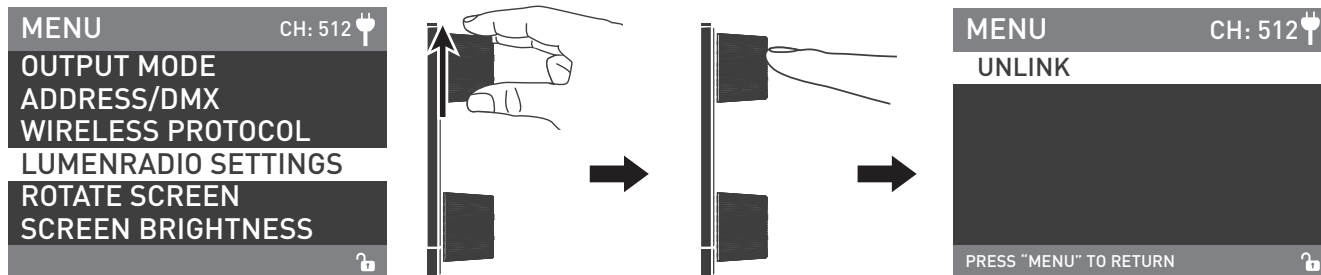
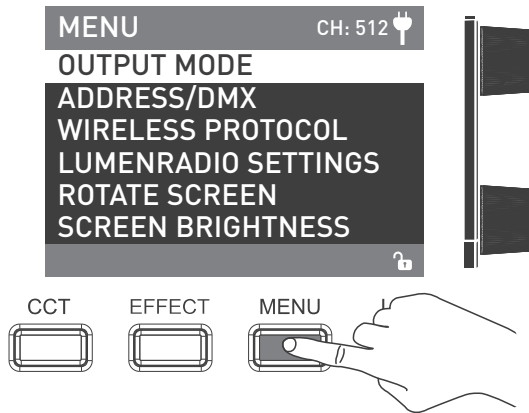

Rotate "Upper knob" to LUMENRADIO SETTINGS and press "Upper knob" to enter the corresponding secondary menu.

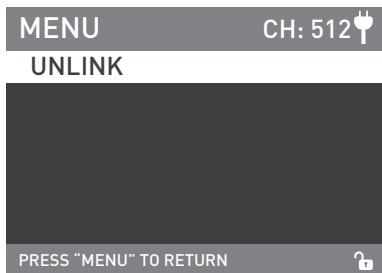

Rotate "Upper knob" to enter the next menu.

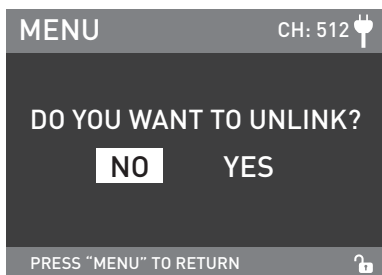
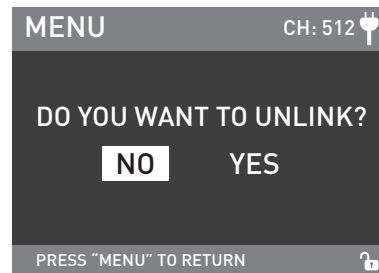
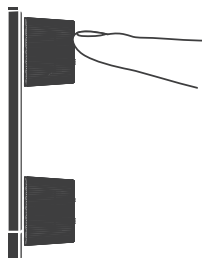

Rotate "Upper knob" to select YES and press "Upper knob" to set.

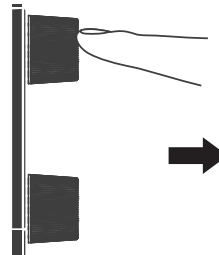
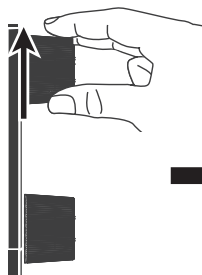

② Connect the fixture or CRMX wireless DMX transmitter set to TRANSMITTER MODE with the fixture needs to receive CRMX wireless DMX signals for remote control.

Note: The LUMENRADIO SETTINGS of the fixture should be set to UNLINK, then it could reconnected by a new fixture or transmitter.

## Operation Instructions

1. Make sure the power switch is in the "off" position, then connect the fixture to the power supply with power cable. Then turn on the power switch, if the indicator is normally on, the screen will first display "NANLUX", that means the power is active.

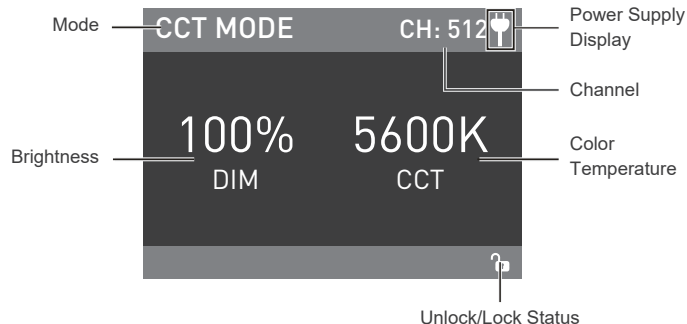

2. CCT Key: Press CCT Key to enter the operation interface of CCT Mode.

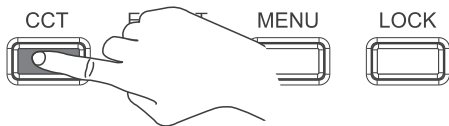
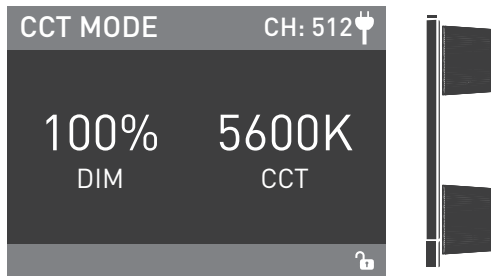

- ① DIM setting: rotate "Lower knob", clockwise to increase brightness while counterclockwise to reduce brightness, the display shows the percentage of brightness, the DIM range is from 0%-100%.

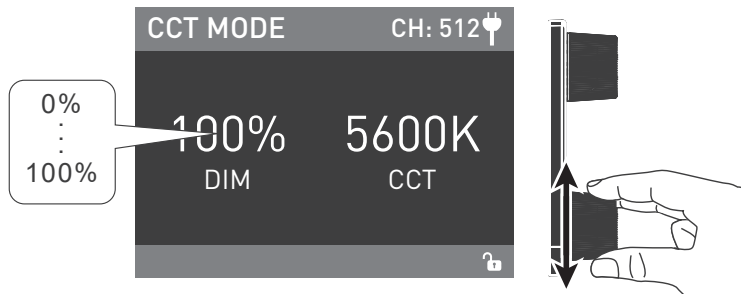

NOTE: In other modes, the DIM range is same as in CCT Mode. When the fixture function is unlock, in any mode, press the "Lower knob", the light is off, the DIM percentage on the display is 0% , press again, the fixture restores the previous status, press continuously to switch brightness between on and off.

- ② CCT setting: rotate "Upper knob", clockwise to increase the color temperature while counterclockwise to reduce the color temperature, the display shows the value of CCT, the CCT range is from 2700K-7500K.

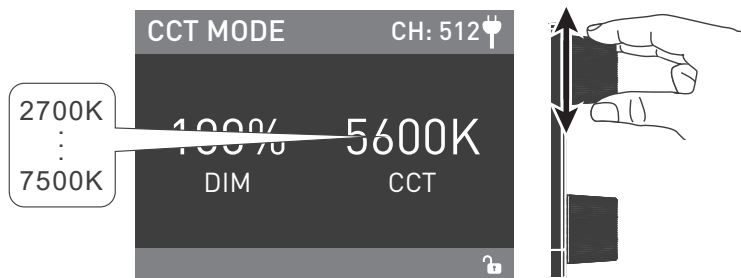

NOTE: Press "Upper knob" to quickly adjust CCT in sequence: 2700K, 3200K, 4300K, 5600K, 6500K, 7500K.

3. EFFECT Key: Press EFFECT Key to enter the operation interface of EFFECT Mode.

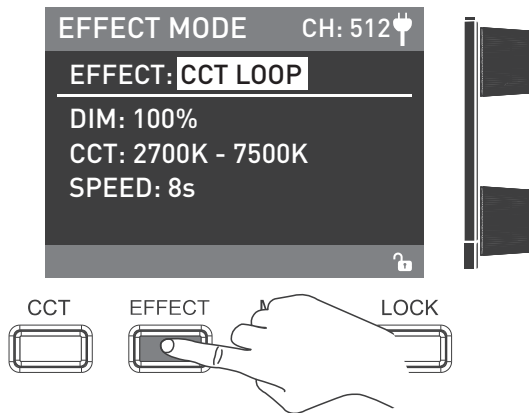

TK-140B and TK-280B has built-in special effects: CCT LOOP, INT LOOP, FLASH, PULSE, STORM AUTO, STORM MANUAL, TV, PAPAZZI, CANDLE/FIRE, BAD BULB, FIREWORK, EXPLOSION AUTO, EXPLOSION MANUAL, WELDING.

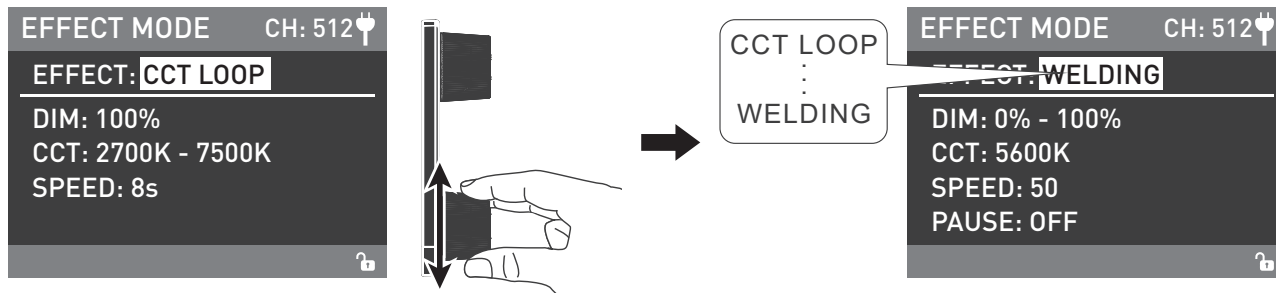

Rotate "Lower knob" to select the desired special effect.



① CCT LOOP

CCT LOOP setting: Rotate "Upper knob" to select DIM, CCT, SPEED (Range: 2s-30s), then rotate "Lower knob" to set the corresponding parameters.

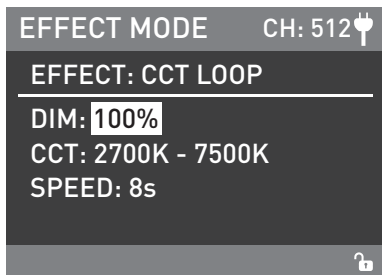

Rotate "Upper knob" to select DIM, CCT, SPEED.

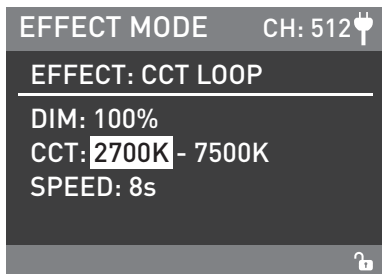
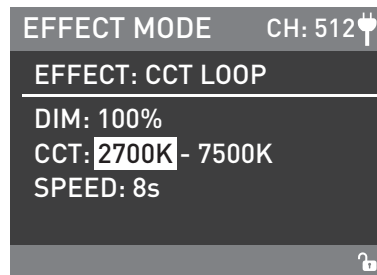

Rotate "Lower knob" to set the corresponding parameters.

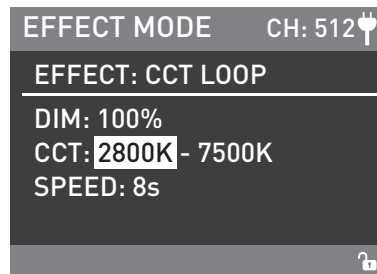

② INT LOOP

INT LOOP setting: Rotate "Upper knob" to select DIM, CCT, SPEED (Range: 2s-30s), then rotate "Lower knob" to set the corresponding parameters.

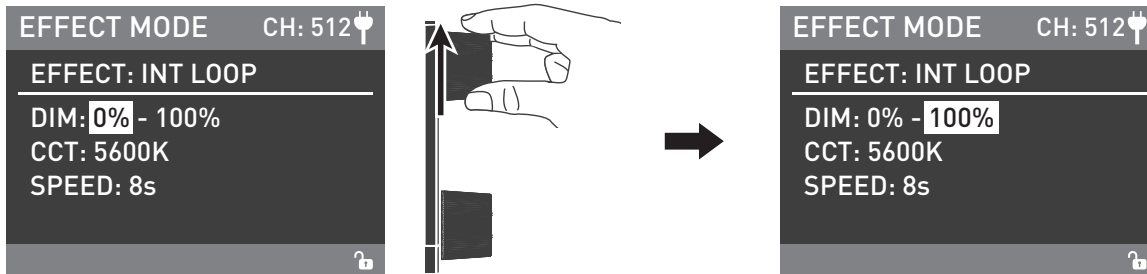

Rotate "Upper knob" to select DIM, CCT, SPEED.

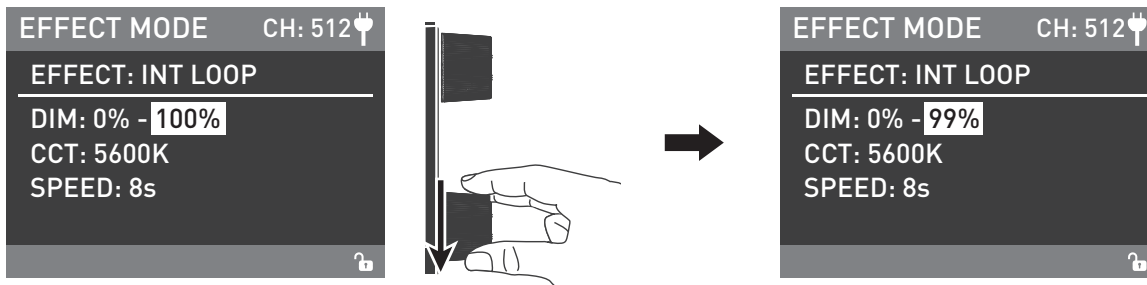

Rotate "Lower knob" to set the corresponding parameters.

③ FLASH

FLASH setting: Rotate "Upper knob" to select DIM, CCT, INTERVALS (Range: 0.1s-10s), FLASH RATIO (Range: 0%-100%), then rotate "Lower knob" to set the corresponding parameters.

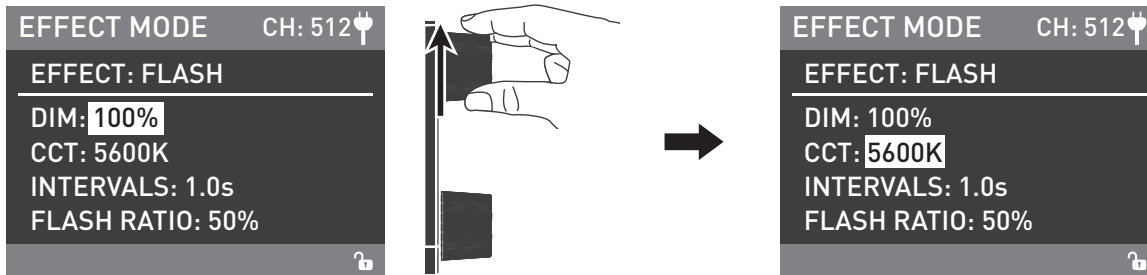

Rotate "Upper knob" to select DIM, CCT, INTERVALS, FLASH RATIO.

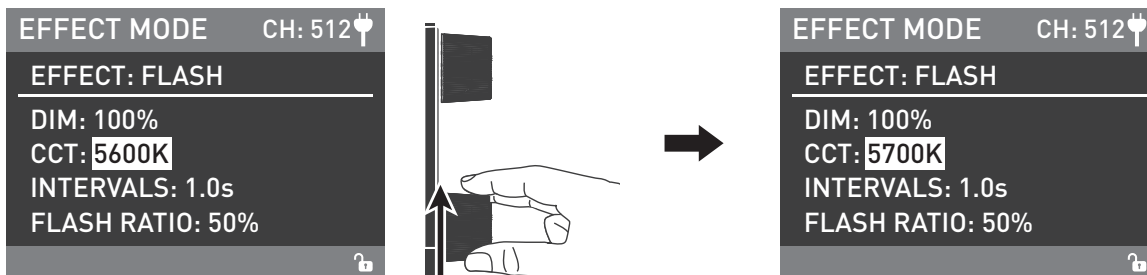

Rotate "Lower knob" to set the corresponding parameters.

④ PULSE

PULSE setting: Rotate "Upper knob" to select DIM, CCT, PULSES/MIN (Range: 1-240), then rotate "Lower knob" to set the corresponding parameters.

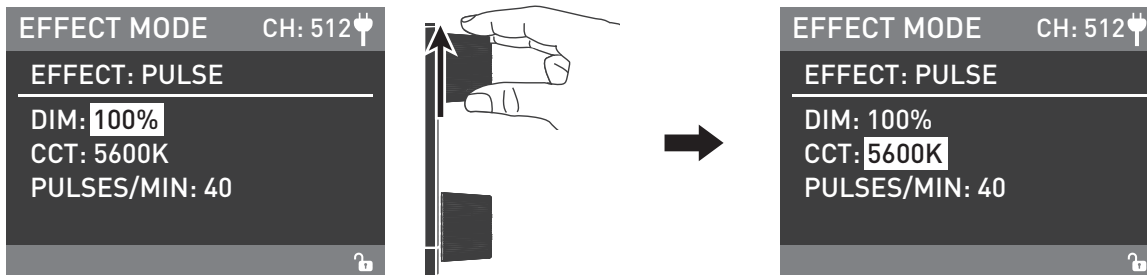

Rotate "Upper knob" to select DIM, CCT, PULSES/MIN.

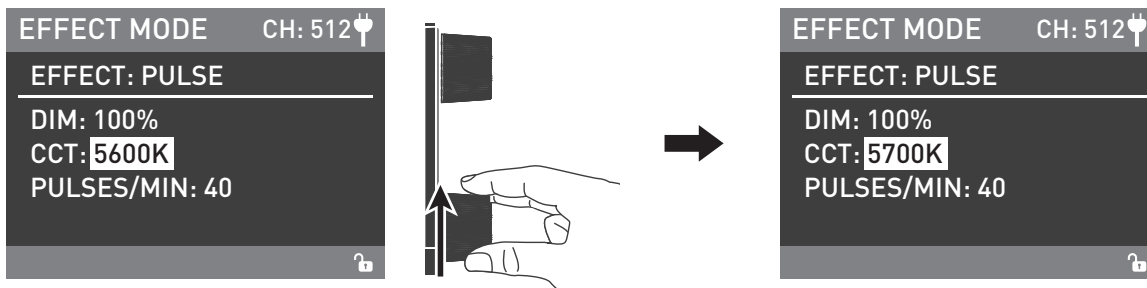

Rotate "Lower knob" to set the corresponding parameters.

⑤ STORM AUTO

STORM AUTO setting: Rotate "Upper knob" to select DIM, CCT, INTERVAL RANGE (Range: 1s-60s), then rotate "Lower knob" to set the corresponding parameters.

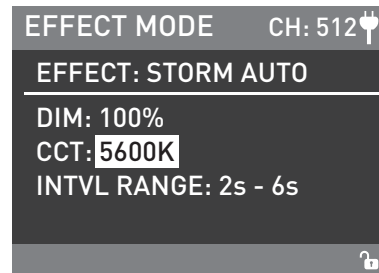
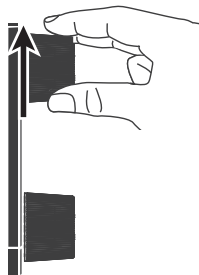
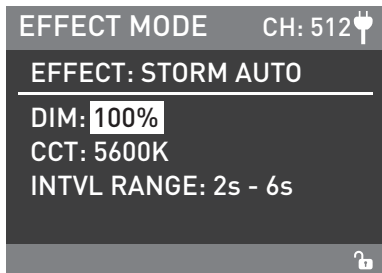

Rotate "Upper knob" to select DIM, CCT, INTERVAL RANGE.

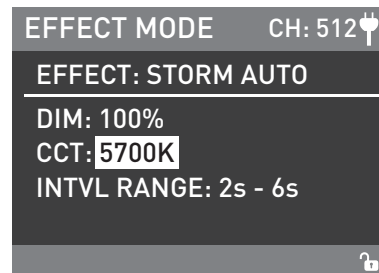
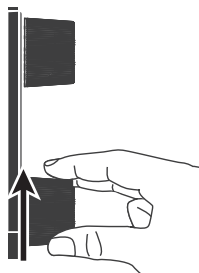
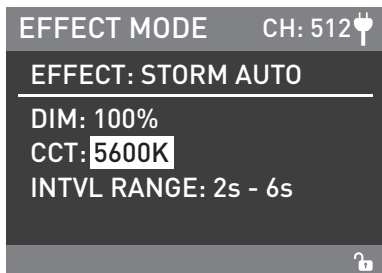

Rotate "Lower knob" to set the corresponding parameters.

⑥ STORM MANUAL

STORM MANUAL setting: Rotate "Upper knob" to select DIM, CCT, then rotate "Lower knob" to set the corresponding parameters. Press "Upper knob" to trigger STORM.

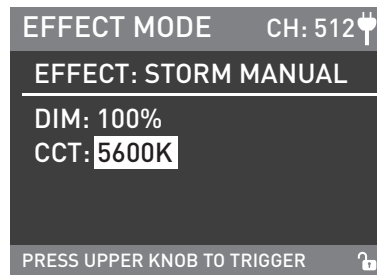
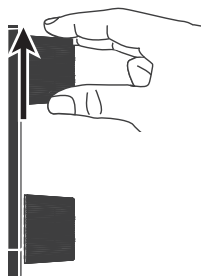
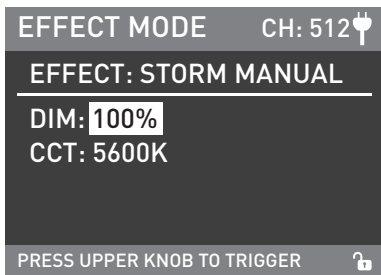

Rotate "Upper knob" to select DIM, CCT.

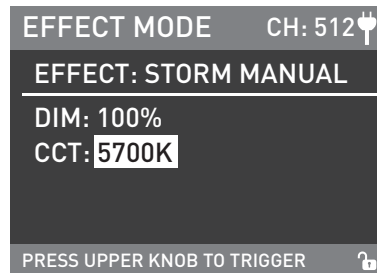
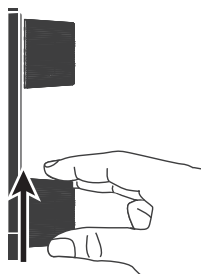
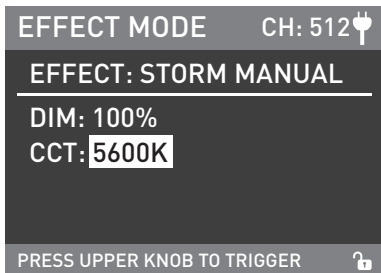

Rotate "Lower knob" to set the corresponding parameters.

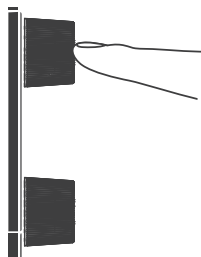
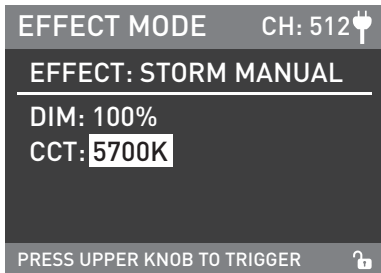

Press " Upper knob" to trigger STORM.

⑦ TV

TV setting: Rotate "Upper knob" to select DIM, CCT, CCT SHIFT (Range: 0K-3000K), SPEED (Range: 1-100), then rotate "Lower knob" to set the corresponding parameters.

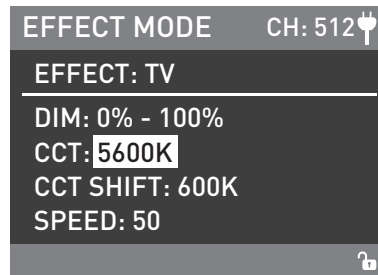
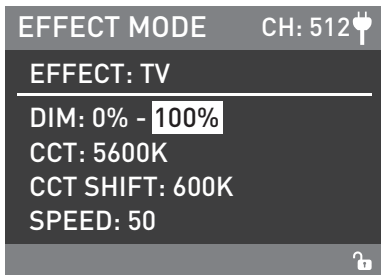

Rotate "Upper knob" to select DIM, CCT, CCT SHIFT, SPEED.

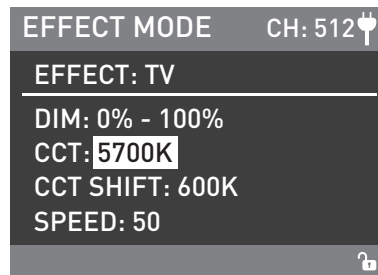
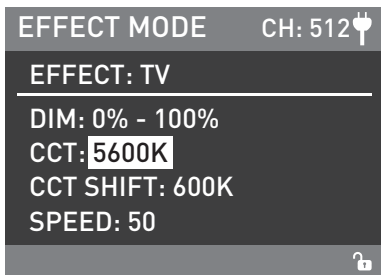

Rotate "Lower knob" to set the corresponding parameters.

Ⓢ PAPAARZZI

PAPAARZZI setting: Rotate "Upper knob" to select DIM, CCT, SPEED (Range: 1-100), then rotate "Lower knob" to set the corresponding parameters.

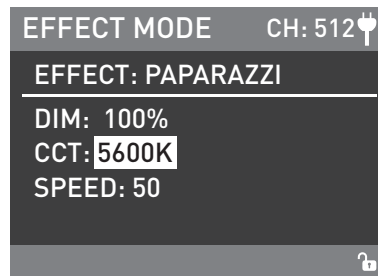
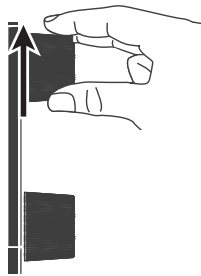
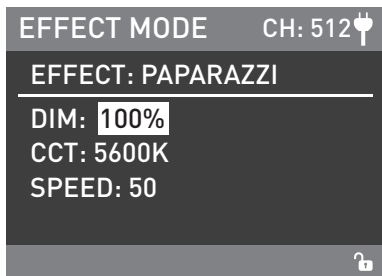

Rotate "Upper knob" to select DIM, CCT, SPEED.

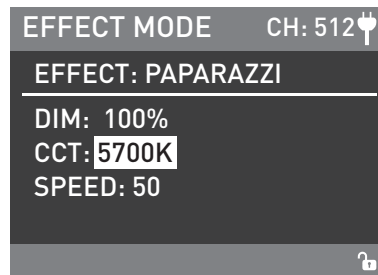
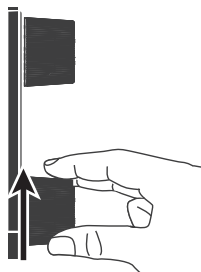
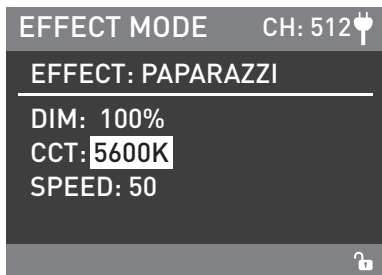

Rotate "Lower knob" to set the corresponding parameters.



⑨ CANDLE/FIRE

CANDLE/FIRE setting: Rotate "Upper knob" to select DIM, CCT, SPEED (adjustment range: 1-100), then rotate "Lower knob" to set the corresponding parameters.

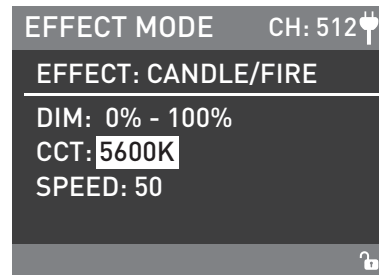
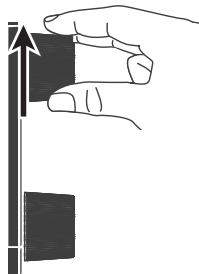
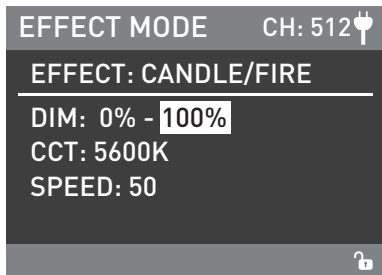

Rotate "Upper knob" to select DIM, CCT, SPEED.

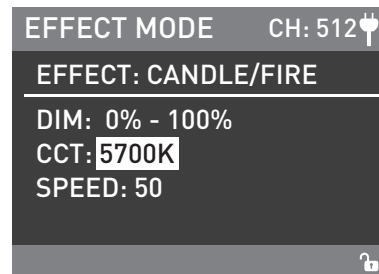
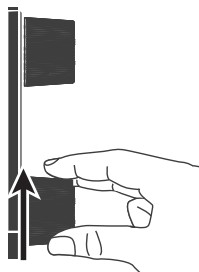
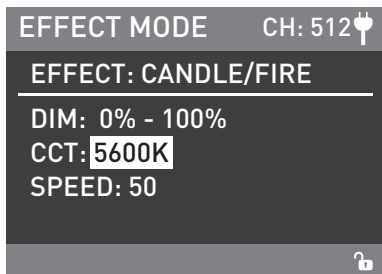

Rotate "Lower knob" to set the corresponding parameters.

⑩ BAD BULB

BAD BULB setting: Rotate "Upper knob" to select DIM, CCT, INTENSITY (Range: 1-100), SPEED (Range: 1-100), then rotate "Lower knob" to set the corresponding parameters.

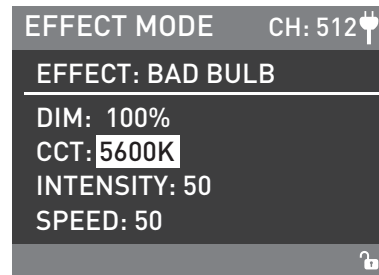
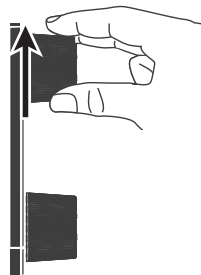
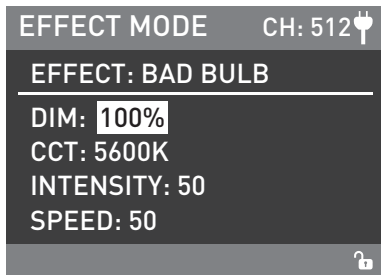

Rotate "Upper knob" to select DIM, CCT, INTENSITY, SPEED.

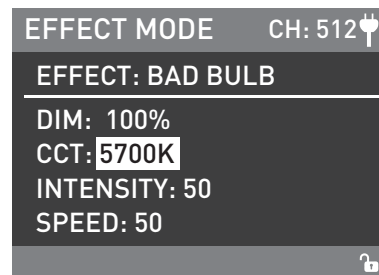
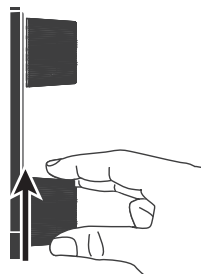
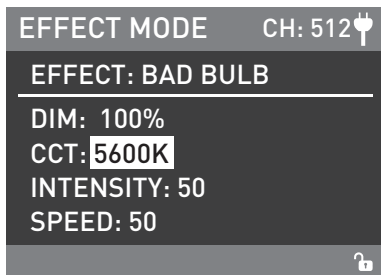

Rotate "Lower knob" to set the corresponding parameters.

⑩ FIREWORK

FIREWORK setting: Rotate "Upper knob" to select DIM, CCT, SPEED (Range: 1-100), DECAY (Range: 1-100), then rotate "Lower knob" to set the corresponding parameters.

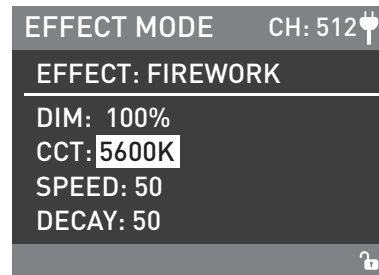
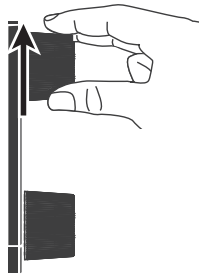
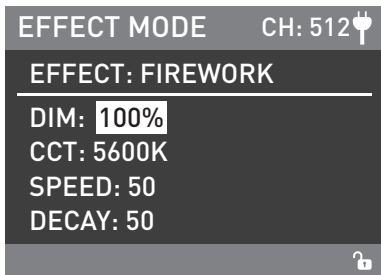

Rotate "Upper knob" to select DIM, CCT, SPEED, DECAY.

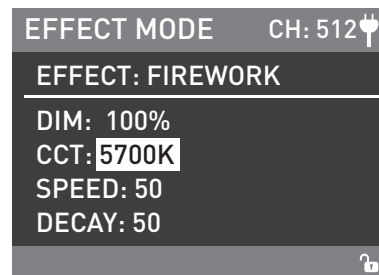
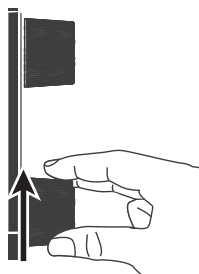
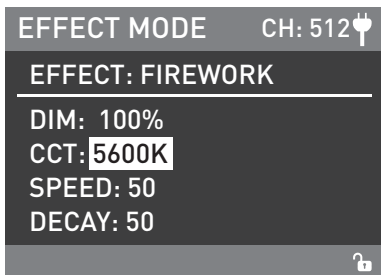

Rotate "Lower knob" to set the corresponding parameters.

⑫ EXPLOSION AUTO

EXPLOSION AUTO setting: Rotate "Upper knob" to select DIM, CCT, SPEED (Range: 1-100), DECAY (Range: 1-100), then rotate "Lower knob" to set the corresponding parameters.

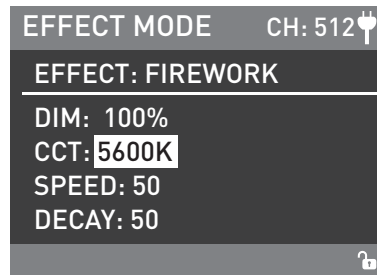
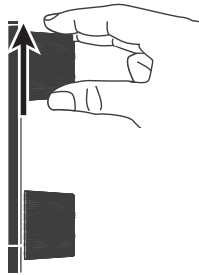
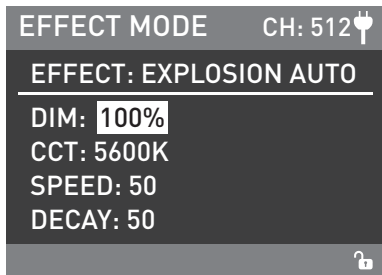

Rotate "Upper knob" to select DIM, CCT, SPEED, DECAY.

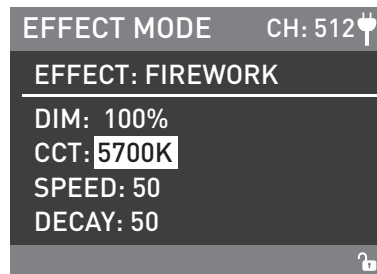
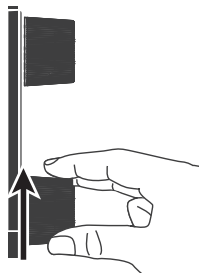
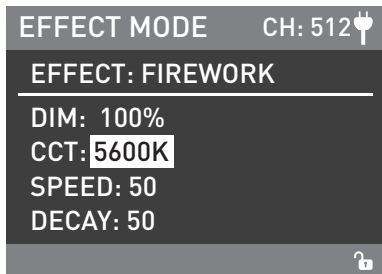

Rotate "Lower knob" to set the corresponding parameters.

⑬ EXPLOSION MANUAL

EXPLOSION MANUAL setting: Rotate "Upper knob" to select DIM, CCT, DECAY (Range: 1-100), then rotate "Lower knob" to set the corresponding parameters. Press "Upper knob" to trigger EXPLOSION.

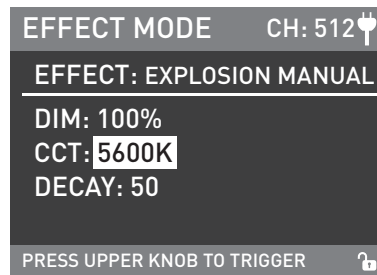
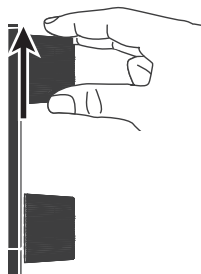
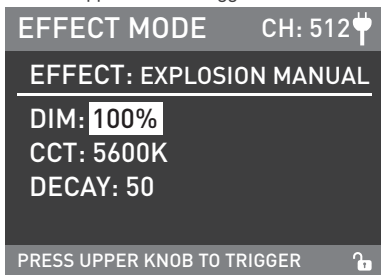

Rotate "Upper knob" to select DIM, CCT, DECAY.

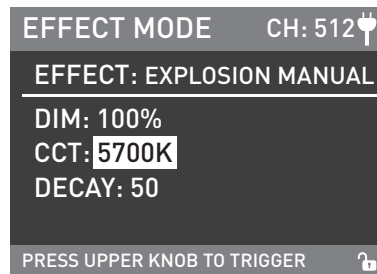
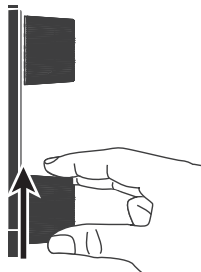
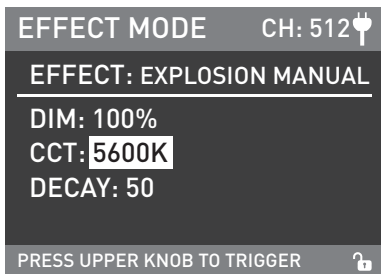

Rotate "Lower knob" to set the corresponding parameters.

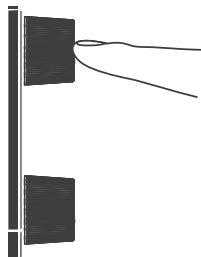
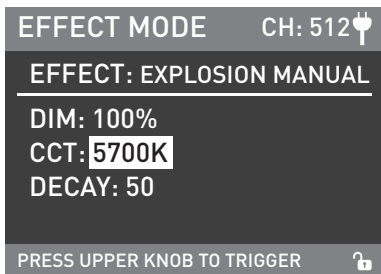

Press "Upper knob" to trigger EXPLOSION.

⑭ WELDING

WELDING setting: Rotate "Upper knob" to select DIM, CCT, SPEED (Range: 1-100), PAUSE (ON / OFF), then rotate "Lower knob" to set the corresponding parameters.

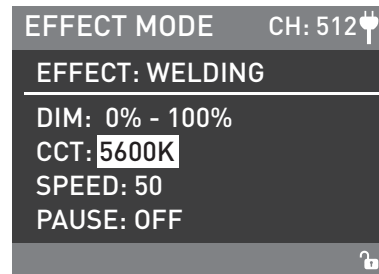
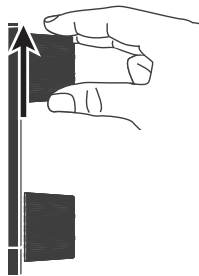
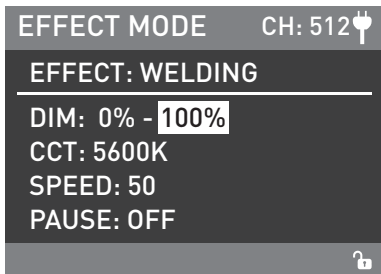

Rotate "Upper knob" to select DIM, CCT, SPEED, PAUSE.

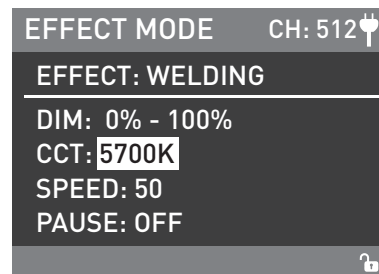
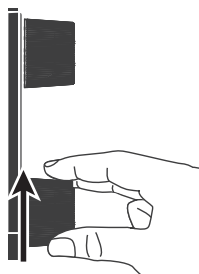
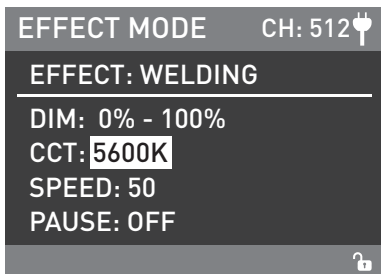

Rotate "Lower knob" to set the corresponding parameters.

NOTE: When the PAUSE is on, WELDING pause.

· Lighting effects and additional functionality maybe added with future firmware releases, for details of these please see [www.nanlux.com](http://www.nanlux.com).

4. MENU Key: Press MENU key to access options.

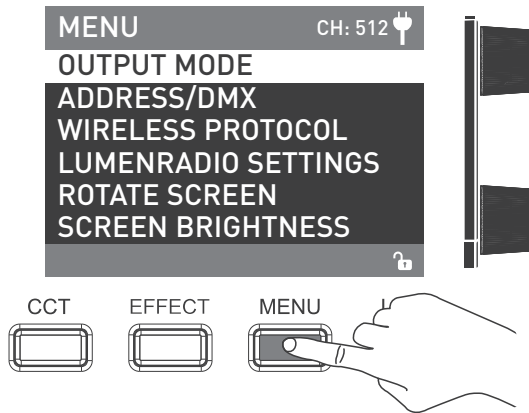

· Rotate "Upper knob" to select setting item, press "Upper knob" to enter corresponding secondary menu, rotate "Upper knob" again to select corresponding option, press "Upper knob" to set. Press MENU key to return to the previous menu.

① OUTPUT MODE

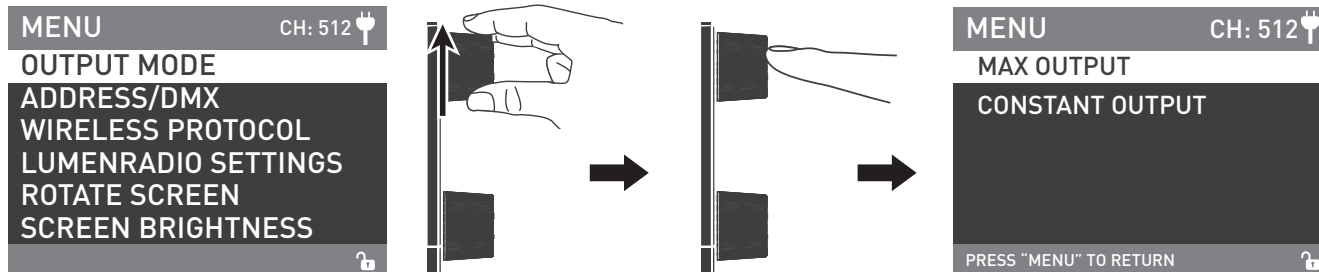

Rotate "Upper knob" to OUTPUT MODE, press "Upper knob" to enter corresponding secondary menu.

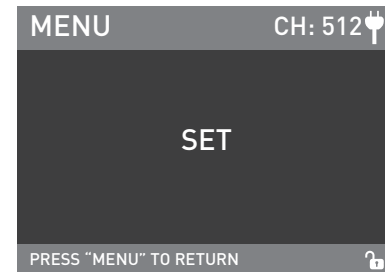
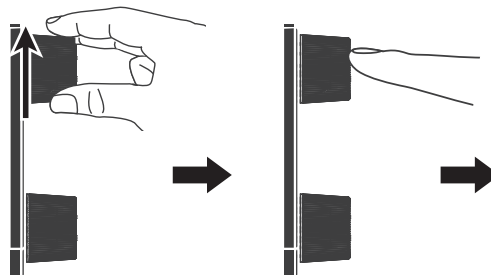
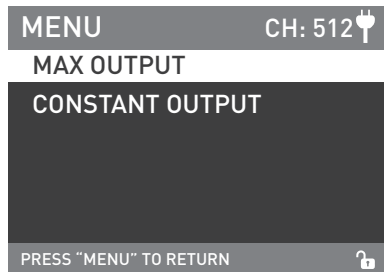

Rotate "Upper knob" to select MAX OUTPUT or CONSTANT OUTPUT and press "Upper knob" to set.

② ADDRESS/DMX

For more operation details please refer to P7.

③ WIRELESS PROTOCOL

For more operation details please refer to P12.

④ LUMENRADIO SETTINGS

For more operation details please refer to P14.



⑤ ROTATE SCREEN

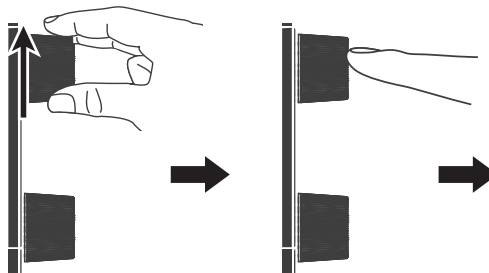
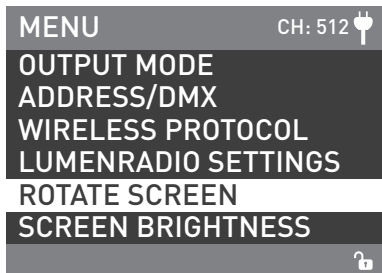

Rotate "Upper knob" to ROTATE SCREEN and press "Upper knob" to enter the corresponding secondary menu.

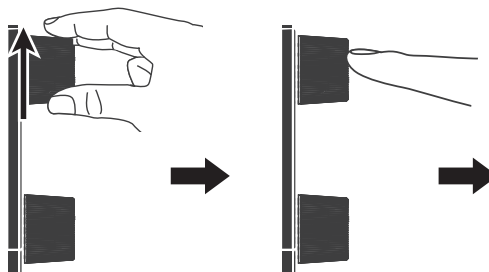
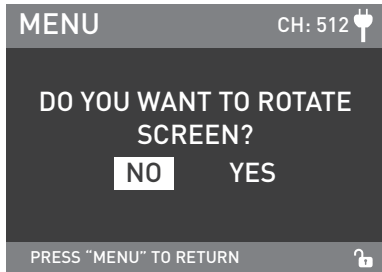
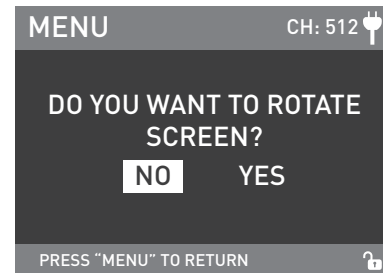

Rotate "Upper knob" to select YES or NO and press "Upper knob" to set.



⑥ SCREEN BRIGHTNESS

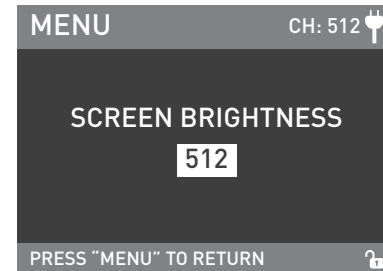
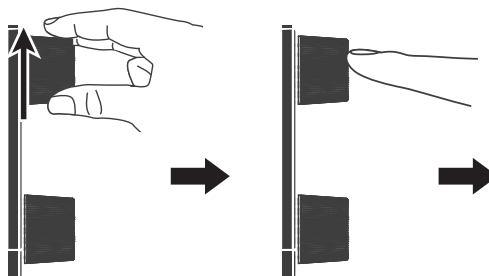
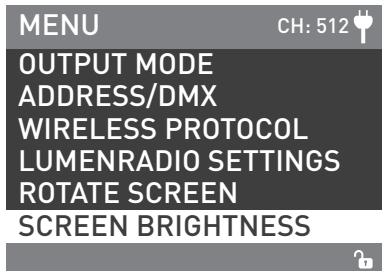

Rotate "Upper knob" to SCREEN BRIGHTNESS and press "Upper knob" to enter the corresponding secondary menu.

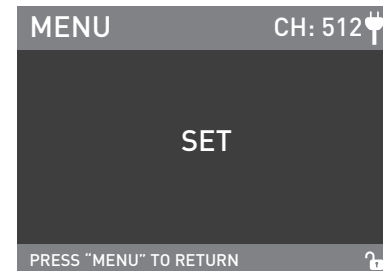
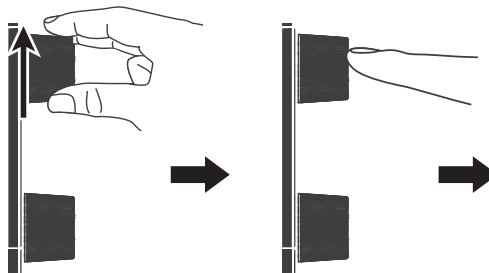
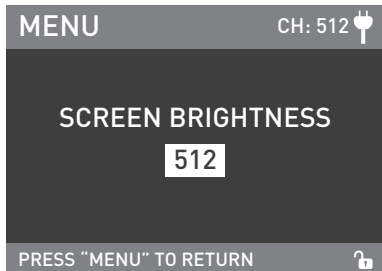

Rotate "Upper knob" to select SCREEN BRIGHTNESS and press "Upper knob" to set.

⑦ BUTTON BACKLIGHT

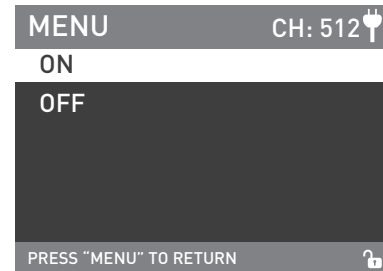
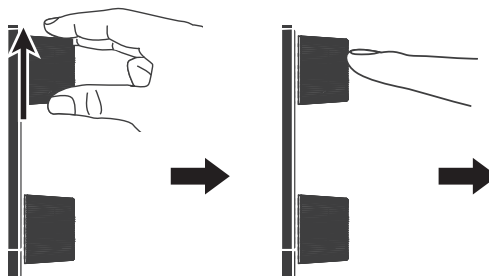
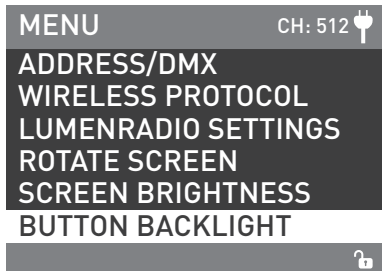

Rotate "Upper knob" to BUTTON BACKLIGHT and press "Upper knob" to enter the corresponding secondary menu.

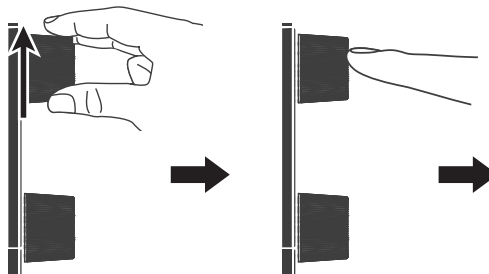
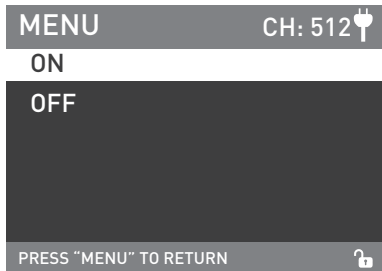

Rotate "Upper knob" to select ON or OFF and press "Upper knob" to set.

⑧ LANGUAGE

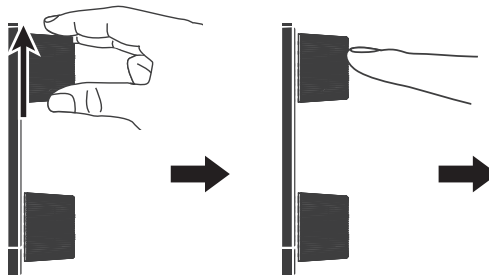
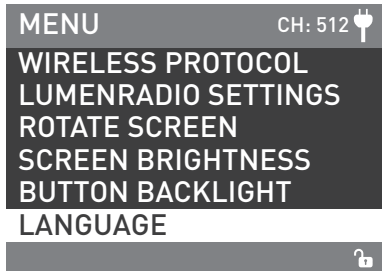

Rotate "Upper knob" to LANGUAGE and press "Upper knob" to enter the corresponding secondary menu.

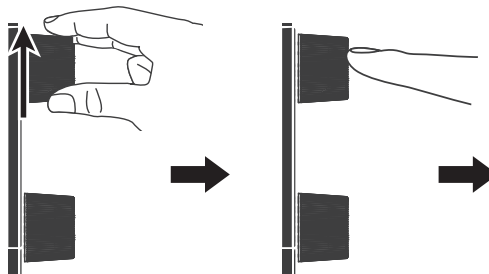

Rotate "Upper knob" to select ENGLISH or 简体中文 and press "Upper knob" to set.

⑨ VERSION

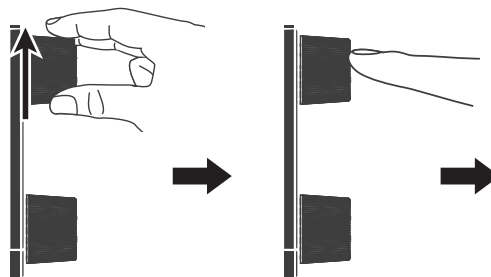
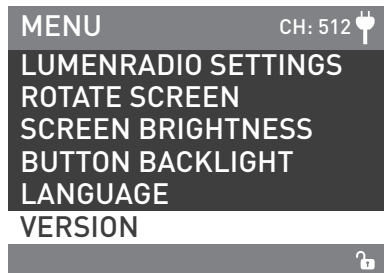

Rotate "Upper knob" to VERSION, and press "Upper knob" to check the current version.

5. LOCK key: Long press the LOCK Key to lock functions, now operation keys or adjustment knobs cannot change the current function, long press the Lock key again to release the Lock status.

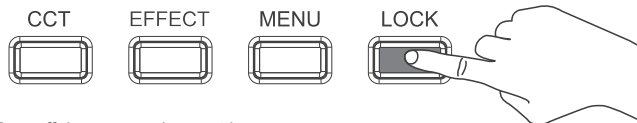
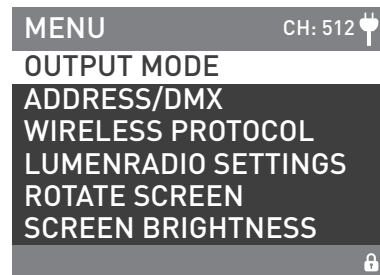
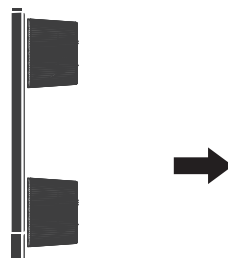
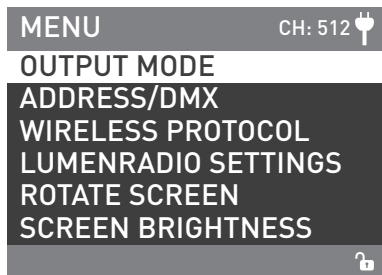

6. Turn off the power when not in use.

## Safety Precautions

1. Please open the package to check for damage caused in transit, if damaged please do not use and contact place of purchase or manufacturer as soon as possible.
2. Do not use a power cable with damaged insulation. Do not unplug hard or drag the power cable directly.
3. Ensure the power supply's voltage matches the voltage specified by the fixture before installation.
4. When cleaning or not using the light, please turn it off.
5. Stored the light safely and away from children.







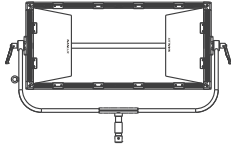
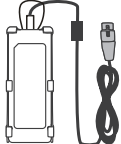

## Notice

1. Do not place any object on the light emitter.
2. Don't place objects on the light or allow liquid to follow inside the fixture or the emitter.
3. Don't place the light near flammable substances like alcohol or gasoline.
4. When cleaning the light, please wipe off debris or dirt by using a dry cloth with clean water or neutral cleanser
5. The light should be operated safely where it won't be at risk of getting wet or under extreme temperature.
6. Don't repair the light by yourself. Attempts to self repair will void warranty, for repairs please return to place of purchase.
7. When using the fixture for a long time, the temperature of the fixture is high, please pay attention to anti-scalding.

## General Fault Detection and Diagnosis

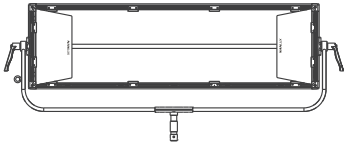
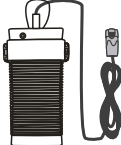
Fault Detection	Diagnosis
The light won't boot up properly!	<ol style="list-style-type: none"> <li>1. Please check the LED indicator. If flashing or not on at all, please check whether the connection between power adapter, power cable and outlet connection is properly connected or loose.</li> <li>2. Please check whether the voltage value is within the specified parameters.</li> <li>3. If using battery, please check if the battery is installed properly, if the voltage of battery is consistent with the specified voltage.</li> </ol>
The fixture can operate by manual, but DMX control is not working.	<ol style="list-style-type: none"> <li>1. Please check whether the DMX original address setting of the fixture is correct or not.</li> <li>2. Check that the XLR signal cable is connected correctly or is damaged.</li> </ol>
LCD display is on, but can't operate the light.	Please check if the LCD display shows "🔒", long press the "LOCK" key for 2 seconds to release the LOCK.
If the failure is not resolved after troubleshooting, please contact place of purchase.	

**What's in the box? Please kindly check.**

TK-140B x 1	Power Supply x 1	Power Cable x 1	DMX Reference Guid x 1	User Manual x 1
				
TK-280B x 1	Power Supply x 1	Power Cable x 1	DMX Reference Guid x 1	User Manual x 1
				

This manual and all stats within it were produced under controlled conditions, and are accurate at time of print. Further details about design or technical data updated please visit [www.nanlux.com](http://www.nanlux.com).

Version: V1 2021-01-11

 +86-754-85751187

 +86-754-85300887

 [info@nanlux.com](mailto:info@nanlux.com)

 Zhanglin,324,Dongli Chenghai Shantou Guangdong China

**Guangdong NanGuang Photo&Video Systems Co., Ltd**